

PCS250 - GPRS/GSM Communicator Module V1.0

P ▲ R ▲ D O X™



Reference and Installation Manual

PARADOX.COM

Printed in Canada - 07/2012

PCS250-EI00

Table of Contents

Introduction.....	4
Features.....	4
Overview.....	6
System Components	6
LED Feedback	7
Specifications	8
Connections	9
SIM Card Connection	9
Optional Power Supply Connections	11
VDMP3 Connection (Optional - GSM mode only).....	12
Using an RS485 Link.....	13
Using an External Power Input	14
Antenna Installation	15
Antenna Extension Installation (Optional)	15
Configuring the PCS250	16
Frequency Band	16
Bandwidth Saver Mode	16
Configuring GSM Network Provider Information	16
Configuring WinLoad Access	17
Programming and Registering GPRS Reporting Options	18
SMS Backup Reporting	20
Troubles	22
SMS Language	23
Arm/Disarm System via Text Message	24
List of SMS Commands	25
Upload/Download	26
Public Network (GPRS mode only)	26
Private Network	26
Module Supervision	28
View GSM IP Information	30
Text Messages	32

Chapter 1: Introduction

The PCS250 provides Paradox control panels with wireless communication capabilities to report system events through a GPRS or GSM network to the IPR512 GPRS/IP Monitoring Receiver.

The PCS250 can be configured to send system events to the end-user via SMS. All this is achieved via a simple 4-wire serial connection between the control panel and the PCS250.

The PCS250 can be installed up to 2m (6 ft.) from the panel. An external antenna can be installed up to 18m (60 ft.) from the reporting device using an optional antenna and a cable extension, depending on the local signal strength.

Features

- Report events to the IPR512 GPRS/IP Monitoring Receiver via GPRS or to a landline receiver via GSM
- Report via text message (up to 16 cell phone numbers)
- Control panel communication supervision. When detected, the control panel will generate a trouble as well as report it to the monitoring station via landline
- End user can arm or disarm the system by sending a text message (SMS) to the PCS250
- Send pre-recorded voice messages to up to 8 phone numbers to report alarms using the Paradox Plug-In Voice Module (VDMP3) - *GSM mode*
- Simple installation with 4-wire serial connection
- Optional rod antenna can be installed up to 18m (60ft) from the module using optional antenna cable extensions depending on the local signal strength
- 128-bit (MD5) and 256-bit (AES) encryption - *GPRS mode*
- Increase the distance between the panel and the PCS250 with an RS485 link (GSM mode only (e-bus)). A CVT485 module must be added at the panel in order to accomplish this.

Included Items

- Serial cable
- GPRS14 Module

Required/Optional Items

- Active SIM card (required)
- Paradox Plug-In Voice Module VDMP3 (optional)
- Antenna extension (optional)
- 12 Vdc external power supply (optional)

Compatibility

- EVO48 and EVO192 panels V2.02
- K641 and K641R keypads V1.51 or higher
- SP series V3.42 with K32LCD keypads V1.22
- E55 panels V3.0 (labels to be programmed via Winload)
- E65 panels V2.1 (labels to be programmed via Winload)
- MG series V4.0 or higher with K32LCD keypads V1.22 or higher

For latest updates visit paradox.com

Chapter 2: Overview

This section provides an overview of the Paradox PCS250 Communicator Module. It covers technical specifications, light-emitting diode (LED) functionality, and an overview of the PCS250 system components.

System Components

- 1) GPRS14 with dual SIM card slots
- 2) Audio jack
- 3) InField upgrade connector
- 4) Function switch reserved for future use
- 5) RS485/power terminal
- 6) Future use
- 7) Serial cable connector
- 8) Audio module connector (e.g., VDMP3)
- 9) System LEDs (refer to "LED Feedback" on page 7)

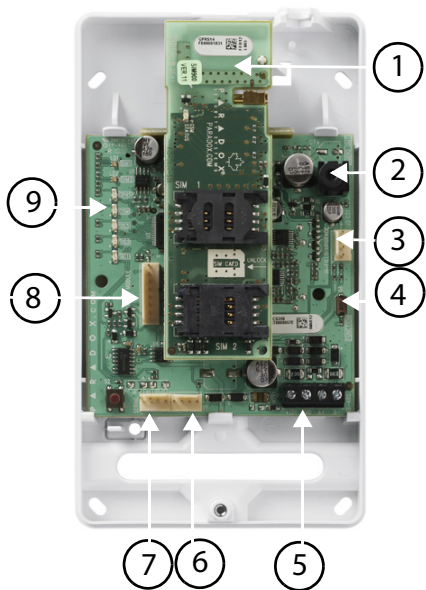

LED Feedback

The following table provides a description of the PCS250 Communicator Module LEDs.

LED	Feedback
SIM Card 1	Solid green = SIM card 1 is installed on the GPRS14 Quick green flashing = SIM card 1 is exchanging data Slow green flashing = Searching the network Solid red = SIM card 1 is defective Off = SIM card 1 is not present
SIM Card 2	Future use
GPRS	Solid green = unit is set for GSM operation Quick green flashing = exchanging data Note: When this LED is ON, the GSM LED stays OFF.
GSM	Solid green = unit is set for GSM operation Quick green flashing = exchanging data Note: When this LED is ON, the GSM LED stays OFF.
Signal Strength	LED 1, 2, and 3 (bottom three LEDs) indicate the strength of the incoming antenna signal.

Communication Loss

Upon loss of communication with the panel, the PCS250 LEDs will behave in the following manner:

- 1) GPRS or GSM LED displays are off; the SIM card and Signal Strength LEDs display their status for about 3 seconds.
- 2) Signal strength LED remains OFF; GSM (green) is turned ON, followed in turn by GPRS (green), SIM2 (orange) and SIM1 (red). When a LED is ON, all others are off. Each LED lights for about 20 sec. This sequence is repeated two times.
- 3) This cycle repeats until communication is restored.

Specifications

The following table describes the technical specifications of the PCS250 Communicator Module.

Power	Class 4 (2W) @ 850/900 MHz Class 2 (1W) @ 1800/1900 MHz
Antenna Bandwidth	70 / 80 / 140 / 170 MHz
Antenna	Gain <3dBi; impedance 50 ohm Input power >2W peak power
Power Input	12Vdc nominal
Consumption	100 mA standby, average 450mA (1.2A peak) during GPRS/GSM transmission
Operating Temperature	0°C to 50°C (32°F to 122°F)
Encryption	128-bit (MD5 and RC4) or 256-bit (AES)
SMS Protocol	8-bit (IRA:ITU-T.50) or 16-bit (UCS2 ISO/IEC10646)

Chapter 3: Connections

The following sections guide you through the steps required to connect the PCS250 prior to mounting the unit.

SIM Card Connection

The PCS250 connects to your Paradox control panel providing wireless communication capabilities to report system events to a monitoring station. The PCS250 supports standard GSM provider SIM cards. The SIM card contains all your cellular telephone account information. In order to activate your SIM card, you must contact your local GSM network provider. It is important to use SIM Card Tray 1, as SIM Card Tray 2 is reserved for future use.

Note: *Prior to setting up your PCS250, it is important that the Personal Identification Number (PIN) of the SIM card be disabled. Refer to your cellular phone's manual for more information on how to disable the PIN.*

To install the SIM card:

- 1) Remove the front cover of the PCS250 Module. If the cover is not installed, proceed to Step 2.
- 2) If an optional VDMP3 module is installed, disconnect the VDMP3 before proceeding to the next step.
- 3) Slide the SIM card tray towards the bottom to unlock it, and then flip the SIM card tray open towards you, as shown in Figure 1.

Note: *Open the SIM tray slowly to avoid damage to the tray.*

- 4) Slide the SIM card into the tray with the cut-off corner towards the bottom left. Close the SIM card tray and slide the tray up to lock it into place.
- 5) Reconnect the VDMP3 module.

Figure 1: SIM Card Installation

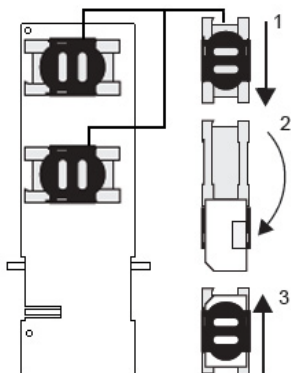

GSM vs. GPRS Connections

The PCS250 is connected directly from the serial cable connector located on the bottom of the unit to the Paradox control panel using the provided serial cable.

Note: *GSM and GPRS reporting cannot be conducted simultaneously. To switch reporting methods, connect the serial cable to the control panel's Serial or EBUS connector and then scan the module. Refer to your Paradox control panel documentation for more information on scanning modules.*

Figure 2: GSM and GPRS Serial Connections

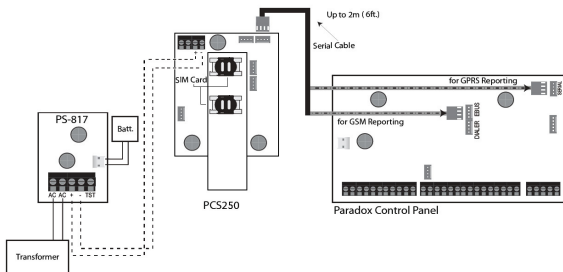

Optional Power Connections

The PCS250 is designed to be powered by the control panel. However, if you want the PCS250 to function even if the control panel battery is low, or if power failures are anticipated, an external power supply with a backup battery (such as the PS817) can be used. For more information on connecting to an external power supply visit paradox.com.

VDMP3 Connection (Optional - GSM mode only)

The Paradox Voice Module (VDMP3) can send pre-recorded voice messages on up to 8 phone numbers to report alarms via the GSM cell phone network. This is done by mounting the VDMP3 directly on the PCS250 Communicator Module, enabling the VDMP3 to dial out using the GSM cell phone network. With the VDMP3 mounted onto the PCS250, the end user can also arm/disarm, request system status, and control PGMs from any telephone.

Note: *When using the VDMP3, certain programming options must be configured. Refer to the control panel programming guide for more information. As well, only one VDMP3 Voice Module can be installed, either on the control panel or the PCS250 GPRS/GSM Communicator Module.*

If the VDMP3 module is installed and the GSM network reception is weak, the volume setting can be adjusted to help improve the VDMP3's response to keys pressed on a telephone. The default volume is 90; this allows for best communication. Valid range values are between 50 to 100, anything outside of this range will reset the command to 90. To adjust the GSM volume the following SMS command must be sent:

P[admin].VOLOUT.[volume value]
e.g., Padmin.VOLOUT.95

Where [admin] is the PCS250 default password (if the password has been changed, enter in the new password) and [volume value] is the new volume level. The PCS250 will receive the SMS message and then adjust the volume setting accordingly.

Using an RS485 Link

When in GSM mode, a CVT485 module can be connected onto the control panel's serial port as an interface to lengthen the distance between the panel and the PCS250 GPRS/GSM Communicator Module. The serial cable provided enables a connection of up to 1m (3 ft.) from the control panel. If the PCS250 has to be installed further from the control panel (e.g., better reception), the CVT485 converts serial to RS485 protocol, allowing a connection of up to 300m (1000 ft.) from the control panel.

While the connection line A+ and B- of the RS485 connector can be extended up to 300m (1000 ft.), the power lines (+12V and ground connections of the RS485 connector) are subject to a shorter length restriction which is based on the wire gauge (this is due to a voltage drop in the lines during transmission). Please refer to Using an External Power Input on page 14 for more details on maximum wire length.

Note: It is possible to connect the RS485 A+ and B- lines to a CVT485 installed on a remote panel and power the PCS250 using a separate 12V power source with shorter wire lengths.

Figure 3: CVT485 Connection

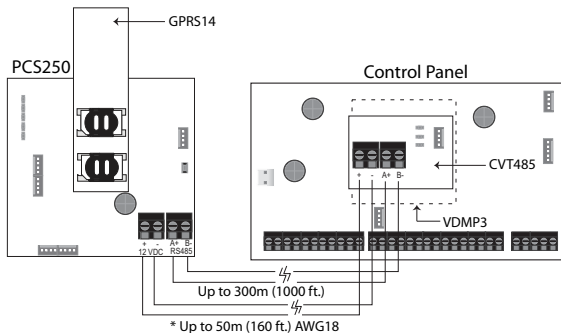

* or use an independent power source for the PCS250

Using an External Power Input

When an external power input is used as a backup power supply, or when the power lines of a RS485 adapter module (CVT485) are used to power the PCS250, the following connections are required:

- Screw 1 = +12V
- Screw 2 = ground

The maximum wire length for each of those power lines is as follows:

- 12m (40 ft.) for AWG24
- 20m (65 ft.) for AWG22
- 30m (100 ft.) for AWG20
- 50m (160 ft.) for AWG18

Chapter 4: Antenna Installation

The PCS250 is equipped with an on-board antenna. To improve RF reception an optional external antenna can be installed together with an extension cable.

Antenna Extension Installation (Optional)

Antenna extensions are available to improve reception by moving the antenna. The antenna extension is sold with a wall-mounting bracket.

To Install the Antenna Extension:

- 1) Use the mounting bracket to mark the holes onto the mounting surface.
- 2) Drill the holes and insert the antenna extension in the bracket until it snaps into place.
- 3) Align the bracket and secure into place using the appropriate mounting hardware.

Note: *There are two knockout holes in the PCS250 enclosure. The one located at the top of the enclosure is used for an extension cable while the other one is used if an external antenna is installed on the box (rod antenna).*

Chapter 5: Configuring the PCS250

The PCS250 can be configured for GSM or GPRS reporting. In order for the unit to provide GSM or GPRS reporting, certain configurations must be set. These configurations include modifying the frequency band, configuring GSM network provider information, configuring the PCS250 for WinLoad access, programming GSM reporting options, and registering and programming GPRS reporting options.

Frequency Band

The PCS250 will automatically be set to a working frequency according to your country.

Bandwidth Saver Mode

The PCS250 can turn off SIM card usage during system inactivity until a new event is sent from the panel. The bandwidth saver mode can be turned ON or OFF by sending the following SMS message to the PCS250.

P[admin].BWS.[value]

e.g., Padmin.BWS.on

Where [admin] is the PCS250 default password (if the password has been changed, enter in the new password) and [value] is either ON or OFF to enable or disable bandwidth saver mode.

Note: *The bandwidth saver mode is turned ON by default.*

Configuring GSM Network Provider Information

To connect the PCS250 to the GPRS network, certain registration parameters must be set (supplied by your GSM network provider). These parameters include the Access Point Name, APN User Name, and the APN Password. To begin the configuration of your GSM network provider information, enter the section programming in your panel.

MG/SP/E	EVO	Feature
[921]	[2960]	APN part 1 (characters 1 - 16)
[922]	[2961]	APN part 2 (characters 17 - 32)
[923]	[2962]	APN user name part 1
[924]	[2963]	APN user name part 2
[925]	[2964]	APN password part 1
[926]	[2965]	APN password part 2
IMPORTANT: This information can be obtained from your GSM network provider.		

Note: When entering into GSM network provider sections, the LCD screen of the control panel's keypad will display either "Labels" or "Messages".

Configuring WinLoad Access

The PCS250 Communicator Module provides remote access for upload and download with WinLoad via a GPRS connection. The following site specific sections must be configured for WinLoad access.

Note: In the case where a reportable event occurs while a WinLoad session is active via GPRS, the communication is terminated to allow event reporting.

MG/SP/E	EVO	Feature	Details
[920]	[2966]	Software port	Default: 10000
[927]	[3013]	Installer software password	Default: admin

Programming GSM Reporting Options

The following sections describe the options that must be programmed in the panel for GSM reporting.

MG/SP/E	EVO	Details
[805]	[2950]	[1] Off + [2] Off = Landline only (default) [1] Off + [2] On = Landline primary / GSM backup [1] On + [2] Off = GSM primary / landline backup [1] On + [2] On = GSM only

Note: The primary phone number is configured via section [815]; the backup phone number is configured in section [817]. A land/GSM account number must be defined in sections [811] and [812] for MG/SP/E and for EVO in sections [3061] through [3068].

Programming and Registering GPRS Reporting Options

The following sections describe the options that must be programmed in the panel for GPRS reporting. Control panels with a PCS250 can also report system events to a monitoring station's IPR512 GPRS/IP Monitoring Receiver.

MG/SP/E	EVO	Feature	Details
[918] [919]	[2976] [2983]	Account / partition registration	MG/SP/E: sections represent account / partition 1 & 2 EVO: sections represent account / partition 1 to 8
[806]	[2975]		[7] Off + [8] Off = Landline only [7] Off + [8] On = GPRS primary / landline backup (default) [7] On + [8] Off = Landline only [7] On + [8] On = Landline & GPRS in parallel

Receiver Settings	MG/SP/E			
Receiver #:	1	2	Backup	
IP address*	[929]	[936]		
IP port**	[930]	[937]	[943]	
IP address WAN2	[931]	[938]	[944]	
IP port WAN2	[932]	[939]	[945]	
Receiver password [†]	[933]	[940]	[946]	
Security profile	[934]	[941]	[947]	
			[948]	
Module registration - press [ARM] to register	[935] [942] [949]			
Receiver Settings	EVO			
Receiver #:	1	2	3	4
IP address*	[2984]	[2986]	[2988]	[2990]
IP port**				
IP address WAN2				
IP port WAN2				
Receiver password [†]				
Security profile				
Module registration - press [ARM] to register	[2985]	[2987]	[2989]	[2991]

* For 1 or 2 digit numbers, add "0s" before the digit: e.g.,

138.002.043.006

** Default 10000

[†] Enter [MEM] for blank space

Note: When entering into Receiver Settings sections, the LCD screen of the control panel's keypad will display "Data" for the receiver password and security profiles sections.

SMS Backup Reporting

The PCS250 Communicator Module now supports SMS backup reporting to an IPRS-7 (IP/GPRS PC Receiver Software) when used in conjunction with a compatible Paradox control panel.

- SP5500/SP6000/SP7000 v4.76
- EVO192 v2.65
- SP4000/SP65 v4.94 (coming soon)
- MG6250 v1.35 (coming soon)

This advanced feature assures continuous communication with the protected premises. With the addition of a GSM/GPRS modem, the IPRS-7 software will be able to receive alarm signals through SMS text messages when GPRS communication is disrupted. Should the GPRS channel fail to transmit from a protected premise because of a power outage or internet failure, a backup SMS will automatically be sent to the IPRS-7 (containing the same CID information of the reportable event).

Configuring the PCS250 for SMS Backup Reporting

Enter the following command to program the receiver's SMS parameters:

- 1) Send the SMS command:
P[PASSWORD].SMS.[GSM MODEM TELEPHONE #].[IPRS-7 PASSWORD] (e.g., Padmin.SMS.5145551111.123456)
- 2) Wait two minutes. The PCS250 will automatically register to the IPRS-7 receiver. This will automatically program the Backup IP receiver, IP address and port as follows:

IP address = 000.000.000.001

Port number = 00001

Backup IP receiver section reference:

Control Panel	IP address	Port	Password	Register IP/GPRS module
SP Series	[943]	[944]	[947]	[935]
EVO Series (IP Receiver #4)	[2990]			[2985]

Enter the following command to view the SMS reporting settings (VSMS):

- 1) Send the VSMS command:
P[PASSWORD].VSMS.[CALLBACK PHONE NUMBER]
(e.g., Padmin.VSMS.5145552222)
- 2) If the SMS reporting parameters are programmed properly, the following SMS will be received:
[SITE ID]
SMS#: [GSM MODEM TELEPHONE # (5145551111)]
Password: [IPRS-7 PASSWORD (123456)]
Status: [IPRS-7 REGISTRATION STATUS]
- 3) If nothing is programmed or the programmed information has been cleared, the following SMS will be received:
[SITE NAME SMS RECEIVER NOT PROGRAMMED]

Enter the following command to clear the programmed SMS parameters:

- **P[PASSWORD].SMS.CLEAR**

SMS commands reference:

SMS - Program the receiver's SMS parameters	P[password].SMS.[GSM modem telephone #].[IPRS-7 password]
VSMS - View the SMS reporting settings	P[password].VSMS.[callback phone number]
Clearing the programmed SMS parameters	P[password].SMS.clear

Control panel programming:

Control Panel	GPRS account #	IP address	Port	Password	Register IP/ GPRS module
SP Series	[918]	[929]	[930]	[933]	[935]
EVO Series	[2976]	[2984]			[2985]

IMPORTANT: Do not register the Backup IP receiver (SP-Series: [949], EVO-Series: [2991]); doing so will delete the PCS250 SMS configuration.

Troubles

The following sections and options have been added to support the IPPR512 GPRS/IP Monitoring Receiver.

MG/SP/E Trouble Group	MG/SP/E Trouble Sub-Group
[4] Communication Trouble	[7] Fail to communicate with receiver [9] GSM network failure [OFF] IP Receiver unregistered (IP/GPRS)
[10] Module supervision loss	[9] GPRS/GSM module
EVO Trouble Group	EVO Trouble Sub-Group
[9] Communication Trouble	[5] Fail to communicate with receiver 1 [6] Fail to communicate with receiver 2 [7] Fail to communicate with receiver 3 [8] Fail to communicate with receiver 4 [9] IP Receiver unregistered (IP/GPRS)

Text message notification

In addition to reporting control panel events via a GSM cell phone network through GSM and GPRS, the PCS250 can also send text messages (SMS) to the end user (up to 16 cell phone numbers). The PCS250 can send text messages for any control panel event due to its proprietary communication through the panel's serial port. Each text message contains a detailed description of the event including site name, date and time, and any associated labels such as zone and serial number. The detailed description of each system event is pre-programmed and hard coded into the PCS250.

MG/SP/E	EVO	Feature	Details
[856]	[2953]	SMS language	Values: 000-255 (see SMS Language)
[780]	[2954]	SMS site name	Default: "Your Alarm Site"

SMS Language

Language	Value	Language	Value
English*	000	Hungarian	009
French	001	Czech	010
Spanish	002	Dutch	011
Italian	003	Croatian	012
Swedish	004	Greek	013
Polish	005	Hebrew	014
Portuguese	006	Russian	015
German	007	Bulgarian	016
Turkish	008	Romanian	017
Language	Value		
Slovak	018		
Chinese	019		
Serbian	020		
Malay	021		
Slovenian	022		

Lithuanian	023		
Finnish	024		
*Default Value = 000			

Note: Some languages are not currently supported. If an unsupported language is selected, messages will be sent in English. Some languages, like Hungarian or Romanian, will generate 2 SMS messages per event reported and other languages will use special LCD characters not supported on all cell phones. Refer to the paradox.com website for the list of languages that are supported, that generate 2 SMS messages, or that use special characters. Refer to the control panel programming guide for information about entering special characters.

Arm/Disarm System via Text Message

It is possible to arm or disarm your system by sending an SMS text message from any cell phone. The message must be sent to the PCS250's phone number, as determined by the cell phone network provider. The text message command has a specific format and specific elements that must be sent to the phone number of the PCS250 module. The format is as follows:

SMS Text Message Format

C[USER CODE].[ACTION].A[PARTITIONS].[PHONE NUMBER]

Examples

Arming example - C1234.ARM.A5.5555551234

Disarming example - C1234.OFF.A5.5555551234

Multiple partitions - C1234.ARM.A1,3,5TO7.5555551234

List of SMS Commands

The following table provides a listing of all SMS commands.

P[password].A.[IP address].P[port number]	Used for GPRS remote access
P[password].IP.[call back phone number]	Used to obtain the IP address of the PCS250
P[password].RESET	Used to reset the PCS250
P[password].BWS.ON	Used to enable bandwidth saver mode
P[password].BWS.OFF	Used to disable bandwidth saver mode
P[password].VOLOUT.[GSM output volume]	Used to set the GSM output volume; values range between 50 to 100
P[password].STATUS.[PHONE NUMBER]	Used to obtain the IP address and IP port of the PCS250 and whether or not the "bandwidth saver" option is being used

Chapter 6: Upload/Download

Fast upload/download can be configured via WinLoad or NEware using a GPRS connection. Upload and download can be achieved on both public and private networks. To find out the type of provider network you are currently set up on, contact your local SIM card provider for more information.

Public Network (*GPRS mode only*)

In order to connect to the GPRS network, you must verify the connection by receiving the IP address of the PCS250 Communicator Module. Before beginning any upload/download procedures you must ensure that the registration parameters of the PCS250 have been set.

Note: It is important that the router used with the PCS250 application (WinLoad and NEware) has been set up for port forwarding to ensure proper system functionality.

To receive the IP address of the PCS250 via text message you must use a cellular phone and enter:

P[TCP/IP password].IP.[phone number to answer back]
i.e. Padmin.IP.5551231234

The PCS250 will send a response to the specified phone number displaying the IP address of the module. This information must be entered into the WinLoad application. The IP address can then be used to configure remote software access.

Private Network

If your SIM card provider is on a private network, communication to the PCS250 must first be established via an SMS message. When the SMS message is sent to the PCS250, the PCS250 will then initiate a connection with WinLoad. Once communication is established, firmware upgrades, as well as upload and download configurations and system programming can begin. Before beginning any upload/download procedures you must ensure that the registration parameters of the PCS250 have been set.

Note: It is important that the router used with the PCS250 application (WinLoad and NEware) has been set up for port forwarding to ensure proper PCS250 system functionality.

To Initiate a GPRS Connection Request via SMS:

- 1) Launch WinLoad.
- 2) Log on to WinLoad by entering your **User** and **Password** information.
- 3) Double-click the account you wish to establish communication with from the Account Group list.
- 4) On the menu bar, click **System** and then click **Wait for call**.
- 5) Enter the SMS text information to be sent to the PCS250 as you see it on screen i.e., "Padmin.A10.10.1.100.P10001".

Chapter 7: Module Supervision

The PCS250 provides several supervision options to ensure that you or your monitoring station is notified of problems such as loss of GSM service or loss of communication with the control panel.

Unique to Paradox, the PCS250 can supervise the presence of the control panel. If communication with the control panel is lost, the PCS250 will send an SMS message. In GSM mode only, the PCS250 can report to the central station that communication to the control panel has been lost (red Error LED will light up).

The PCS250 verifies the presence of the GSM cell phone network approximately every 20 seconds. If the connection is lost, the panel can generate an alarm or trouble after the delay has elapsed (programmed in section [2952] or [855]). When the GSM network connection is lost, the green GSM Connection LED will turn off.

MG/SP/E	EVO	MG/SP/E Details	EVO Details
[805]	[2950]	[5] Off + [6] Off = Module supervision disabled [5] Off + [6] On = Armed: generates a trouble (default) [5] On + [6] Off = Armed: generates an audible alarm [5] On + [6] On = Silent alarm becomes an audible alarm	[5] Off + [6] Off = Module supervision disabled [5] Off + [6] On = Armed: generates an audible alarm [5] On + [6] Off = Armed: generates a trouble (default) [5] On + [6] On = Silent alarm becomes an audible alarm
[855]	[2952]	Set the delay before a GSM No Service trouble is reported. (000 - 255 x 2 sec. / default: 016 (32 sec.)	

End User SMS Programming

With Master Programming, you can:

- Set which phone numbers (up to 8 with MG/SP/ E-Series or 16 with Digiplex EVO) will receive text messages sent by the PCS250 to report system events.
- Select from which area the PCS250 will send text messages (per phone number).
- Select which event groups (alarm, arm/disarm, trouble and trouble restore) will generate text messages.

End User SMS Programming with Digiplex EVO

- 1) Enter the control panel [MASTER CODE] then press [0] to access Master Programming.
- 2) Press [1] to enter the SMS settings menu.
- 3) Select which phone number you wish to program ([01] to [16]).
- 4) Enter or modify the phone number - up to 32 characters. To go to the next screen press [ENTER].
- 5) Select which partitions are enabled for that SMS number by enabling options [1] to [8]. Press [ENTER] to go to the next screen.
- 6) To select which events generate an SMS message, enable or disable options [1] to [4].
- 7) To save press [ENTER].
- 8) After saving or in the main SMS settings menu press [▼] to see which SMS numbers ([01] to [16]) are programmed. To program the SMS number currently displayed, press [ACC].

End User SMS Programming with MG/SP / E-Series

- 1) To access Master Programming, press the [⓪] key.
- 2) Enter [MASTER CODE].
- 3) To enter SMS Setup, press [ARM].
- 4) Using the [▲] and [▼]* or [STAY] keys, select one of the eight telephone numbers you wish to program and press [ENTER].
*With K10LEDV/H or K636 keypads, use [SLEEP] for [▲] and [STAY] for [▼].
- 5) Enter or modify the phone number - up to 32 characters. To go to the next screen press [ENTER].
- 6) Select the SMS Event Call Options you wish to apply to the telephone number.
- 7) To save press [ENTER].
- 8) Select which areas are assigned to this telephone number. To save, press [ENTER].

SMS Phone Number Special Characters for EVO panels	
*	[stay]
#	[force]
+	[arm]
Other panels	
*	[off]
#	[bypass]
+	[mem]

Event Call Options	
Option	Events that send SMS
[1]	Any Alarm
[2]	Arming and Disarming
[3]	Any Trouble
[4]	Any Trouble Restore
[5] to [8]	Future Use

View GSM IP Information

It is possible to view the following GSM IP information in Master Programming:

- **IP Address:** Access this to determine which IP address to enter in the WinLoad or NEware GPRS connection settings. The IP address is determined automatically when the PCS250 connects to the GSM network. In order to properly read the IP address assigned, the GPRS LED must be on.
- **IP Port:** Access this to determine which IP port to enter in the WinLoad or NEware GPRS connection settings. This is the port that the module will listen for incoming GPRS communication. This port is programmed in section [2966] with Digiplex EVO or [920] with MG Series, SP Series, E-Series.
- **User PC Software Password:** This password is needed to connect to the control panel using the NEware software. This password is determined in the NEware software.

Viewing GSM IP Information with Digiplex EVO

- 1) To access Master Programming, enter the [MASTER CODE] then press [0].
- 2) In Master Programming, press [2] to display the PCS250 IP information.
- 3) The first screen displays the PCS250 IP Address. Press [▼] to access the next screen.
- 4) The second screen displays the PCS250 IP Port. Press [▼] to access the third screen.
- 5) The third screen displays the PCS250 User PC Software Password. If you press [▼] again, the Exit Message will be displayed.

Viewing GSM IP Information with MG/SP / E-Series

- 1) Press the [] key.
- 2) Enter [MASTER CODE].
- 3) To enter SMS Setup, press [ARM].
- 4) Using the [▲] key, scroll up to [9] GSM IP Address and press [ENTER]. To return to the GSM menu, press [ENTER].
- 5) Using the [▲] key, scroll up to [10] GSM IP Port and press [ENTER]. To return to the GSM menu, press [ENTER].
- 6) Using the [▲] key, scroll up to [11] GSM PC Password (Future use). To return to the GSM menu, press [ENTER].
- 7) Using the [▲] key, scroll up to [12] Site Name. To return to the GSM menu, press [ENTER].
- 8) To exit the GSM menu, press [CLEAR].

Chapter 8: Text Messages

The following table lists all pre-defined text messages that can be sent. These messages follow the 8-bit or 16-bit SMS protocol and include the elements from the information column. The messages will also use the labels programmed in the system for the site name, area name, zone name, user name, and module name.

Alarm Messages

Message	Information*
Alarm cancelled	1-2-3-4
Alarm cancelled with remote	1-2-3-4
Alarm cancelled through Internet	1-2-3-4
Alarm cancelled through End-User PC Software	1-2-3-4
Alarm cancelled through Voice Module (Phone)	1-2-3-4
Alarm cancelled through SMS	1-2-3-4
Alarm cancelled with keyswitch	1-2-3-5
Alarm cancelled through Installer PC Software	1-2-3
ALARM	1-2-3-4
FIRE ALARM	1-2-3-4
DURESS ALARM	1-2-3-4
PANIC ALARM	1-2-3-4
MEDICAL PANIC ALARM	1-2-3-4
FIRE PANIC ALARM	1-2-3-4
PARAMEDIC PANIC ALARM	1-2-3-4

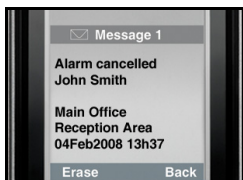

- * Information Index
- 1: Site Name
 - 2: Date and Time
 - 3: Area Name
 - 4: Zone / User / Module Name
 - 5: ID
 - 6: Module Serial Number

Arming/Disarming Messages

Message	Information*
Arming	1-2-3-4
Arming with remote	1-2-3-4
Arming through internet	1-2-3-4
Arming through end-user PC software	1-2-3-4
Arming through voice module (phone)	1-2-3-4
Arming through SMS	1-2-3-4
Arming with keyswitch	1-2-3-5
Arming through Installer PC software	1-2-3
One-touch arming	1-2-3
Auto-arming	1-2-3
Disarming	1-2-3-4
Disarming with remote	1-2-3-4
Disarming through internet	1-2-3-4
Disarming through end-user PC software	1-2-3-4
Disarming through voice module (phone)	1-2-3-4
Disarming through SMS	1-2-3-4
Disarming with keyswitch	1-2-3-5
Disarming through Installer PC software	1-2-3

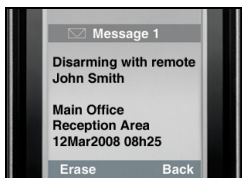

- * Information Index
- 1: Site Name
 - 2: Date and Time
 - 3: Area Name
 - 4: Zone / User / Module Name
 - 5: ID
 - 6: Module Serial Number

Trouble Event Messages

Message	Information*
AC power failure on control panel	1-2
Battery failure on control panel	1-2
Bell overload on control panel	1-2
Bell disconnected from control panel	1-2
Phone line trouble on control panel	1-2
Pager communication from control panel failed	1-2-5
Central station communication from control panel failed	1-2-5
Voice communication from control panel failed	1-2
Installer PC communication from control panel failed	1-2
Date and time loss on control panel	1-2
RF interference detected on system's wireless communication	1-2
Tamper trouble on module	1-2-4-6
Phone line trouble on module	1-2-4-6
Central station communication from module failed	1-2-4-6
Printer module trouble	1-2-4-6
AC power failure on bus or wireless module	1-2-4-6
Battery failure on bus or wireless module	1-2-4-6
Auxiliary power overload on bus or wireless module	1-2-4-6
Missing module	1-2-4-6
Tamper trouble on zone	1-2-3-4-6
Trouble on fire zone	1-2-3-4-6
Low battery on wireless zone	1-2-3-4-6
Missing wireless zone (supervision loss)	1-2-3-4-6
Auxiliary power overload on control panel	1-2
Communication with GSM network lost	1-2
GSM communication with control panel lost	1-2

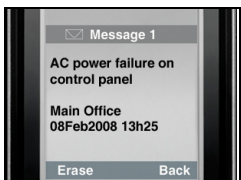

- * Information Index
- 1: Site Name
 - 2: Date and Time
 - 3: Area Name
 - 4: Zone / User / Module Name
 - 5: ID
 - 6: Module Serial Number

Trouble Restore Messages

Message	Information*
AC power restored on control panel	1-2
Battery power restored on control panel	1-2
Bell restored on control panel	1-2
Bell connected on control panel	1-2
Phone line restored on control panel	1-2
Central station communication from control panel restored	1-2-5
Date and time restored on control panel	1-2
System wireless communication restored	1-2
Tamper restored on module	1-2-4-6
Phone line restored on module	1-2-4-6
Central station communication from module restored	1-2-4-6
Printer module restored	1-2-4-6
AC power restored on bus or wireless module	1-2-4-6
Battery power restored on bus or wireless module	1-2-4-6
Auxiliary power restored on bus module	1-2-4-6
Missing module restored	1-2-4-6
Tamper restored on module	1-2-3-4-6
Fire zone restored	1-2-3-4-6
Battery on wireless zone restored	1-2-3-4-6
Wireless zone restored	1-2-3-4-6
Auxiliary power restored on control panel	1-2
Communication with GSM network restored	1-2
GSM communication with control panel restored	1-2

Index

A

Access Point Name	13
Alarm messages	29
Antenna	8
Antenna bandwidth	8
Antenna extension	12
Antenna installation	12
APN password	13
APN user name	13
Arm/disarm	21
Audio jack	6

B

Bandwidth saver mode	13
----------------------------	----

C

Cancel SMS	28
Compatibility	5
Configuring the PCS250	13
Consumption	8
CTV485	4, 13, 14

D

Default volume	11
DigiPlex EVO	26, 28

E

E55/E65	5
Encryption	8
Error	22
Error LED	25
Event call options	27
EVO192	5
EVO48	5
External power input	11

G

GPRS	7
GPRS network	13
GPRS reporting	15
GSM	7

GSM cell phone network	25
GSM connection LED	25
GSM reporting	15
GSM reporting options	13
GSM vs. GPRS connections	10

I

Included items	5
IP address	27
IP port	27
IPRS12 GPRS/IP Monitoring Receiver	15
IPRS-7	17

K

K641	5
K641R	5

L

LED	6
LED feedback	7
Light-emitting diodes	6
List of SMS commands	22
Loss of GSM service	25

M

Master programming	26
MG Series	5
MG/SP / E-Series	26, 28

N

NEware	23
--------------	----

O

Operating temperature	8
-----------------------------	---

P

PCS200 reset	22
Power input	8
Power supply	10
Power supply connections	10
Pre-defined text messages	29
Private network	23
Public network	23

R

Registration parameters	13
Required/optional items	5
Reset	22
RS485 link	4, 13, 14

S

Serial cable	10
Serial cable connector	10
Signal strength	7
SIM card connection	9
SIM card error	7, 22
SMS backup reporting	17
SMS commands	22
SMS message	25
SMS phone number special characters	27
SMS protocol	8
SMS text message format	21
SP Series	5
Specifications	8
System components	6
System features	4

T

Technical specifications	8
Troubles	15

U

Upload/download	23
User PC software password	27

V

VDMP3	10
VDMP3 connection	10
VOLOUT	11
Volume	11

W

Wait for call	24
Wall-mount installation	12
WinLoad	23
WinLoad access	13, 14

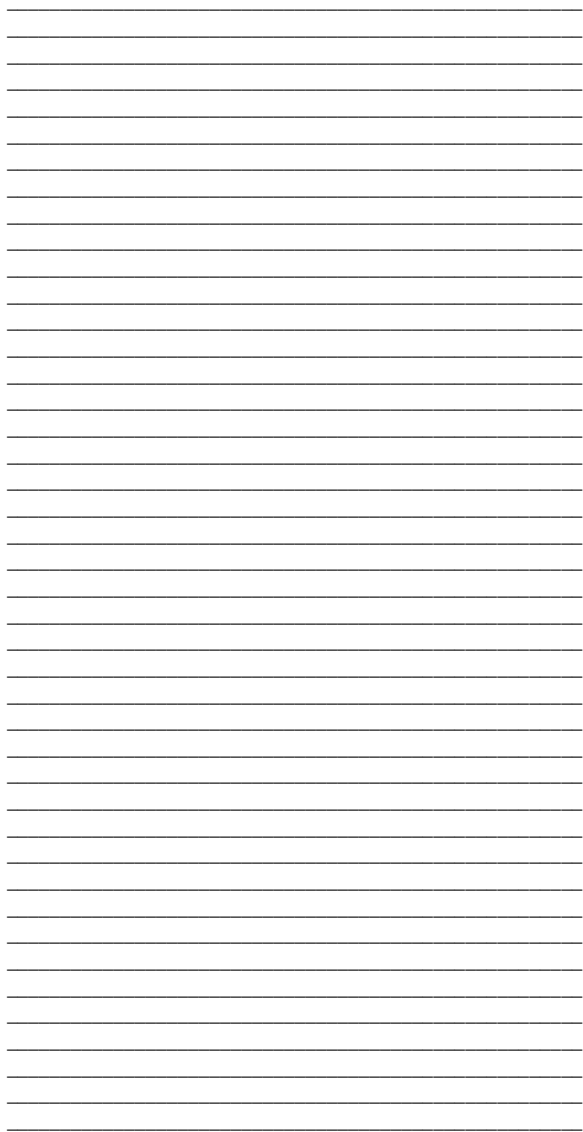

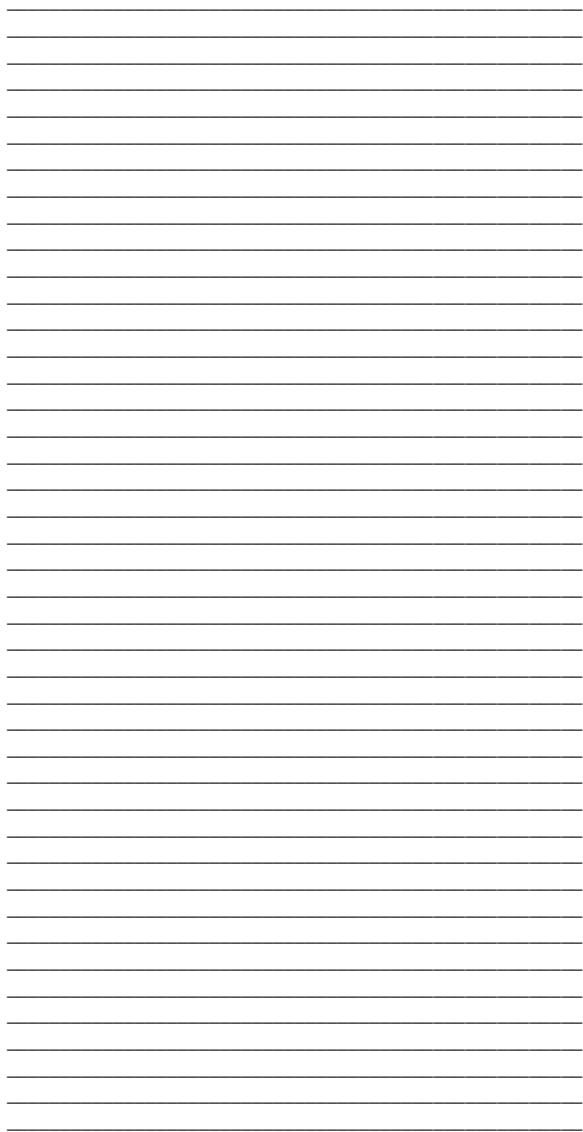

Warranty

For complete warranty information, please visit www.paradox.com/terms. Your use of the Paradox product signifies your acceptance of all warranty terms and conditions. PCS250, Magellan, Spectra SP, EVO, and WinLoad are trademarks or registered trademarks of Paradox Ltd. or its affiliates in Canada, the United States and/or other countries. For the latest product approvals, such as UL and CE, please visit www.paradox.com.
© 2012 Paradox Ltd. All rights reserved. Specifications may change without prior notice.

Patents

One or more of the following US patents may apply: 7046142, 6215399, 6111256, 6104319, 5920259, 5886632, 5721542, 5287111, and RE39406 and other pending patents may apply. Canadian and international patents may also apply.

For technical support in Canada or the U.S., call 1-800-791-1919,
Monday to Friday from 8:00 a.m. to 8:00 p.m. EST.
For technical support outside Canada and the U.S., call 00-1-450-
491-7444, Monday to Friday from 8:00 a.m. to 8:00 p.m. EST.
Please feel free to visit our website at www.paradox.com.