



# Rexon

Full Height Turnstiles & Full Height Gates



## **REXON FULL HEIGHT TURNSTILES**

Our full height REXON turnstiles and gates are suited for indoor and outdoor access control applications in industrial entrances, sports arenas, construction sites and other facilities.

In order to achieve a high security turnstile solution without manned monitoring, the REXON turnstile range guarantees reliable operation in indoor and outdoor conditions.



REXON full height turnstiles come with a motorized drive unit which provides greater reliability, lower maintenance and faster throughput than the traditional mechanical and electromechanical units.

A powerful electromagnetic brake ensures complete protection against unauthorized passage.

## BENEFITS

- Motor driven unit with a powerful electromagnetic brake
- Adaptable rotation speed barrier based on the passenger's movement
- Single and double versions for all projects
- Wide range of models including full height gates for wide passage lanes

## CONTENTS

REXON		GATES	
4 - 5	REXON DEA 3 REXON DEA 3-U REXON DEA DUO 3	24 - 25	GATE DEA GATE DEA DUO GATE DEA-U GATE DEA DUO-U
6 - 7	REXON DEA 3 GATE-BIKE REXON DEA 3 GATE-BIKE-U	26 - 27	GATE ERA GATE ERA DUO GATE ERA-U GATE ERA DUO-U
8 - 9	REXON DEA 3 GATE-FULL REXON DEA 3 GATE-FULL-U	28 - 29	GATE ERA LE GATE ERA DUO LE GATE ERA LE-U GATE ERA DUO LE-U
10 - 11	REXON DEA 4 REXON DEA DUO 4	30 - 33	SPECIFICATION OVERVIEW
12 - 13	REXON ERA 3 REXON ERA DUO 3	34 - 35	OPTIONS & ACCESSORIES
14 - 15	REXON ERA 3 GS REXON ERA DUO 3 GS REXON ERA 3 GS-U		
16	REXON ERA 3 GATE-BIKE		
17	REXON ERA 4		
18 - 19	REXON ERA 4-LE REXON ERA DUO 4-LE		
20 - 21	REXON GLASS 1600 REXON GLASS 1800		
22	REXON BASIC 3		



## REXON DEA 3

## REXON DEA 3-U

## REXON DEA DUO 3

### Type

REXON DEA 3  
 REXON DEA DUO 3  
 REXON DEA 3-U

Full height motorized turnstile with side panels and roof  
 3 door wings  
 Bi-directional passage

### Drive Mechanism

Fail-Safe with Go Call function

### Operating Environment

Outdoor  
 Indoor

### Optional Accessories

Heel protector \*  
 RFID reader bracket  
 Identification or Ticket terminal bracket  
 Access Light including bracket  
 Lane Light including bracket  
 Ceiling Light  
 USB convertor / Ethernet convertor  
 EasyTouch / TouchPanel  
 T-MON SW  
 Power supply backup  
 Alternative surface finishes  
 WAV Player

\* Not available for version with U-shaped arms.

### REXON DEA 3



### REXON DEA 3-U



### REXON DEA DUO 3



<b>Barrier type</b>	11 straight arms with black plastic covering caps $\varnothing$ 40 mm / 1.57"	6 trombone style U-shaped arms $\varnothing$ 22 mm / 0.87"	11 straight arms with black plastic covering caps $\varnothing$ 40 mm / 1.57"
<b>Unit height</b>	2 465 mm / 97.05"	2 465 mm / 97.05"	2 465 mm / 97.05"
<b>Unit width</b>	1 400 mm / 55.12"	1 400 mm / 55.12"	2 520 mm / 99.20"
<b>Passage height</b>	2 100 mm / 82.68"	2 100 mm / 82.68"	2 100 mm / 82.68"
<b>Passage width</b>	620 mm / 24.41"	620 mm / 24.41"	620 mm / 24.41"
<b>Casework</b>	hot-dip zinc galvanized, powder coated finish in RAL colour per specs	hot-dip zinc galvanized, powder coated finish in RAL colour per specs	hot-dip zinc galvanized, powder coated finish in RAL colour per specs
<b>Barrier</b>	hot-dip zinc galvanized	hot-dip zinc galvanized	polished stainless steel

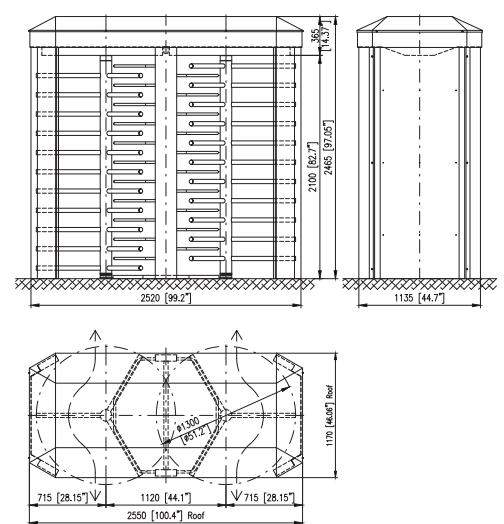
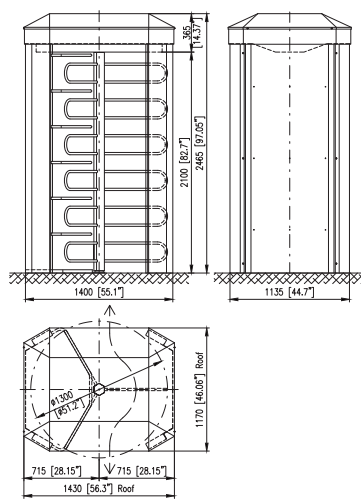
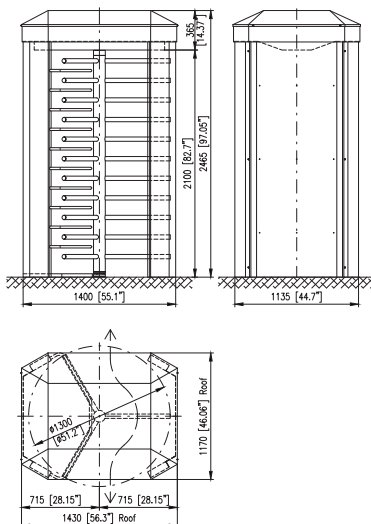



## REXON DEA 3 GATE-BIKE REXON DEA 3 GATE-BIKE-U

### Type

REXON DEA 3 GATE-BIKE  
REXON DEA 3 GATE-BIKE-U

Full height motorized turnstiles with integrated bicycle gate  
3 door wings  
Bi-directional passage

### Drive Mechanism

Fail-Safe with Go Call function

### Operating Environment

Outdoor  
Indoor

### Optional Accessories

Induction loop system for detection of bicycles and scooters  
Heel protector \*  
RFID reader bracket  
Identification or Ticket terminal bracket  
Access Light including bracket  
Lane Light including bracket  
Ceiling Light  
USB convertor / Ethernet convertor  
EasyTouch / TouchPanel  
T-MON SW  
Power supply backup  
Alternative surface finishes  
WAV Player

\* Not available for version with U-shaped arms.

## REXON DEA 3 GATE-BIKE



<b>Barrier type</b>	11 straight arms with black plastic covering caps $\varnothing$ 40 mm / 1.57"
<b>Unit height</b>	2 465 mm / 97.05"
<b>Unit width</b>	2 330 mm / 91.73"
<b>Unit width for scooters</b>	2 520 mm / 99.21"
<b>Passage height</b>	2 100 mm / 82.68"
<b>Passage width</b>	620 mm / 24.41"
<b>Passage width for bicycles</b>	540 mm / 21.25"
<b>Passage width for scooters</b>	730 mm / 28.74"
<b>Casework</b>	hot-dip zinc galvanized, powder coated finish in RAL colour per specs
<b>Barrier</b>	hot-dip zinc galvanized

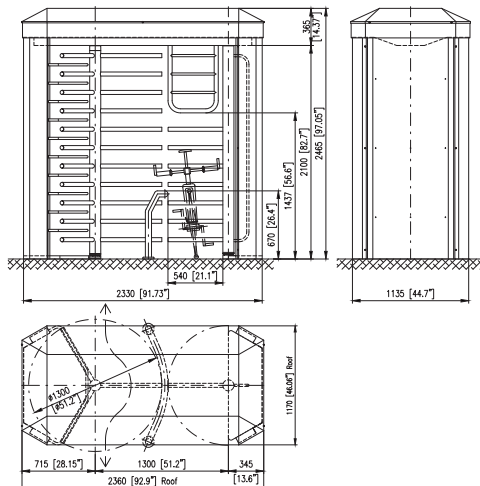

## REXON DEA 3 GATE-BIKE-U



<b>Barrier type</b>	6 trombone style (U-shaped) arms $\varnothing$ 22 mm / 0.87"
<b>Unit height</b>	2 465 mm / 97.05"
<b>Unit width</b>	2 330 mm / 91.73"
<b>Unit width for scooters</b>	2 520 mm / 99.21"
<b>Passage height</b>	2 100 mm / 82.68"
<b>Passage width</b>	620 mm / 24.41"
<b>Passage width for bicycles</b>	540 mm / 21.25"
<b>Passage width for scooters</b>	730 mm / 28.74"
<b>Casework</b>	hot-dip zinc galvanized, powder coated finish in RAL colour per specs
<b>Barrier</b>	polished stainless steel

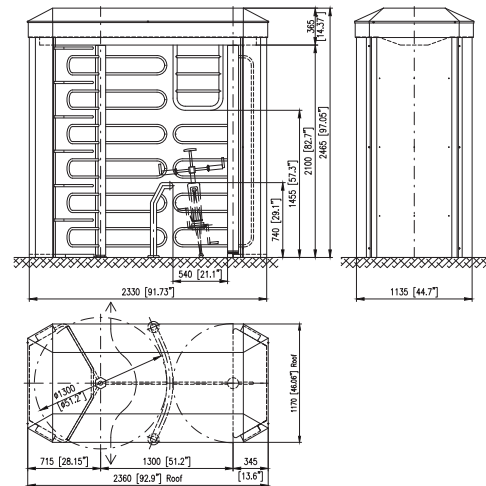



## REXON DEA 3 GATE-FULL REXON DEA 3 GATE-FULL-U

### Type

REXON DEA 3 GATE-FULL  
REXON DEA 3 GATE-FULL-U

Full height motorized turnstile with integrated full-height gate  
3 door wings  
Bi-directional passage

### Drive Mechanism

Fail-Safe with Go Call function

### Operating Environment

Outdoor  
Indoor

### Optional Accessories

Heel protector \*  
RFID reader bracket  
Identification or Ticket terminal bracket  
Access Light including bracket  
Lane Light including bracket  
Ceiling Light  
USB convertor / Ethernet convertor  
EasyTouch / TouchPanel  
T-MON SW  
Power supply backup  
Alternative surface finishes  
WAV Player

\* Not available for version with U-shaped arms.



## REXON DEA 3 GATE-FULL



<b>Barrier type</b>	11 straight arms with black plastic covering caps $\varnothing$ 40 mm / 1.57"
<b>Unit height</b>	2 465 mm / 97.05"
<b>Unit width</b>	2 590 mm / 101.97"
<b>Passage height</b>	2 100 mm / 82.68"
<b>Passage width</b>	620 mm / 24.41"
<b>Passage width of gate</b>	standard 800 mm / 31.49"
<b>Passage width of gate</b>	maximum 900 mm / 35.43"
<b>Casework</b>	hot-dip zinc galvanized, powder coated finish in RAL colour per specs
<b>Barrier</b>	hot-dip zinc galvanized

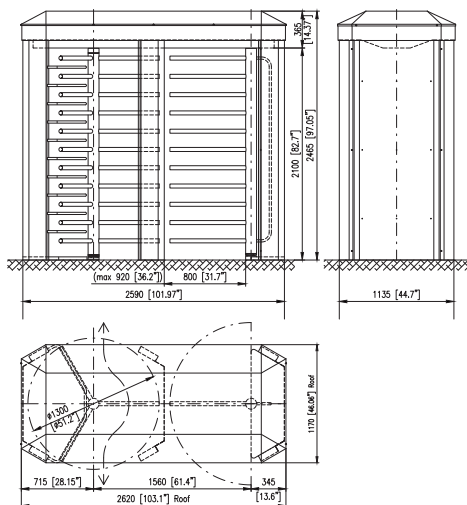

## REXON DEA 3 GATE-FULL-U



<b>Barrier type</b>	6 trombone style (U-shaped) arms $\varnothing$ 22 mm / 0.87"
<b>Unit height</b>	2 465 mm / 97.05"
<b>Unit width</b>	2 590 mm / 101.97"
<b>Passage height</b>	2 100 mm / 82.68"
<b>Passage width</b>	620 mm / 24.41"
<b>Passage width of gate</b>	standard 800 mm / 31.49"
<b>Passage width of gate</b>	maximum 900 mm / 35.43"
<b>Casework</b>	hot-dip zinc galvanized, powder coated finish in RAL colour per specs
<b>Barrier</b>	polished stainless steel

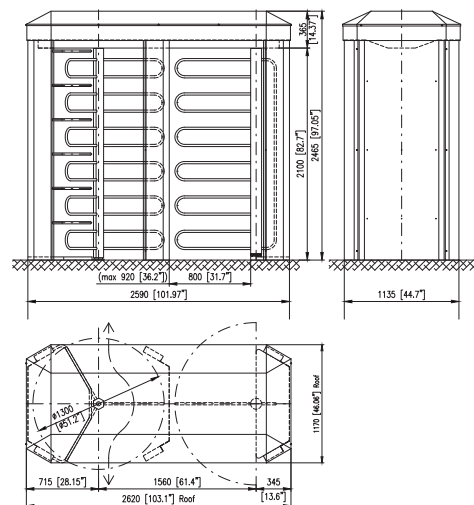



## REXON DEA 4 REXON DEA DUO 4

### Type

REXON DEA 4  
REXON DEA DUO 4

Full height motorized turnstile  
4 door wings  
Bi-directional passage

### Drive Mechanism

Fail-Safe with Go Call function

### Operating Environment

Outdoor  
Indoor

### Optional Accessories

Heel protector  
RFID reader bracket  
Identification or Ticket terminal bracket  
Access Light including bracket  
Lane Light including bracket  
Ceiling Light  
USB convertor / Ethernet convertor  
EasyTouch / TouchPanel  
T-MON SW  
Power supply backup  
Alternative surface finishes  
WAV Player

## REXON DEA 4



<b>Barrier type</b>	11 straight arms with black plastic covering caps $\varnothing$ 40 mm / 1.57"
<b>Unit height</b>	2 550 mm / 100.39"
<b>Unit width</b>	1 440 mm / 56.69"
<b>Passage height</b>	2 100 mm / 82.68"
<b>Passage width</b>	550 mm / 21.65"
<b>Casework</b>	stainless steel AISI 304 brushed finish
<b>Barrier</b>	stainless steel AISI 304 brushed finish

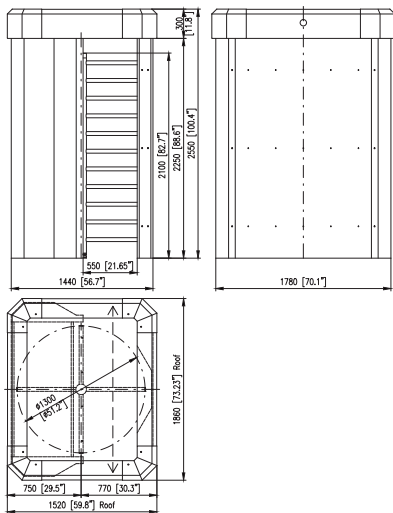

## REXON DEA DUO 4



<b>Barrier type</b>	11 straight arms with black plastic covering caps $\varnothing$ 40 mm / 1.57"
<b>Unit height</b>	2 550 mm / 100.39"
<b>Unit width</b>	2 235 mm / 88.00"
<b>Passage height</b>	2 100 mm / 82.68"
<b>Passage width</b>	550 mm / 21.65"
<b>Casework</b>	stainless steel AISI 304 brushed finish
<b>Barrier</b>	stainless steel AISI 304 brushed finish

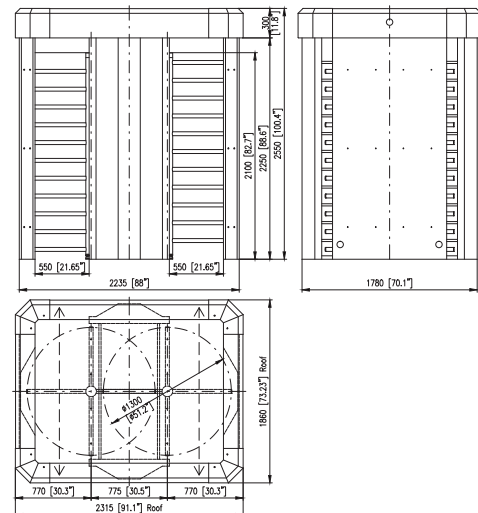



## REXON ERA REXON ERA DUO 3

### Type

REXON ERA 3  
REXON ERA DUO 3

Full-height motorized turnstile  
3 door wings  
Bi-directional passage

### Drive Mechanism

Fail-Safe with Go Call function

### Operating Environment

Outdoor  
Extreme outdoor \*  
Indoor

### Optional Accessories

Heel protector  
RFID reader bracket  
Identification or Ticket terminal bracket  
Access Light including bracket  
Lane Light including bracket  
Ceiling Light  
Canopy LT  
USB convertor / Ethernet convertor  
EasyTouch / TouchPanel  
T-MON SW  
Power supply backup  
Alternative surface finishes  
WAV Player

\* As an option

## REXON ERA 3



## REXON ERA DUO 3



<b>Barrier type</b>	11 straight arms with black plastic covering caps $\varnothing$ 40 mm / 1.57"
<b>Unit height</b>	2 520 mm / 99.21"
<b>Unit width</b>	1 540 mm / 60.63"
<b>Passage height</b>	2 100 mm / 82.68"
<b>Passage width</b>	644 mm / 25.35"
<b>Frame</b>	hot-dip zinc galvanized
<b>Top panel</b>	hot-dip zinc galvanized, powder coated finish in RAL 7040
<b>Barrier</b>	hot-dip zinc galvanized

<b>Barrier type</b>	11 straight arms with black plastic covering caps $\varnothing$ 40 mm / 1.57"
<b>Unit height</b>	2 520 mm / 99.21"
<b>Unit width</b>	2 360 mm / 92.91"
<b>Passage height</b>	2 100 mm / 82.68"
<b>Passage width</b>	644 mm / 25.35"
<b>Frame</b>	hot-dip zinc galvanized
<b>Top panel</b>	hot-dip zinc galvanized, powder coated finish in RAL 7040
<b>Barrier</b>	hot-dip zinc galvanized

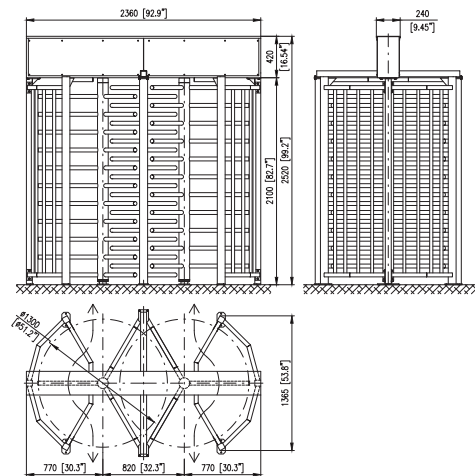
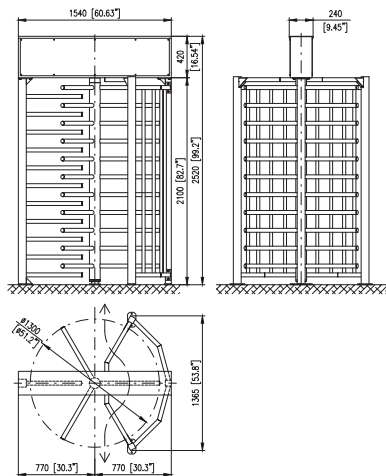



## REXON ERA 3 GS

## REXON ERA DUO 3 GS

## REXON ERA 3 GS-U

### Type

REXON ERA 3 GS  
 REXON ERA DUO 3 GS  
 REXON ERA 3 GS-U

Full-height motorized turnstile with side glass panels  
 3 door wings  
 Bi-directional passage

### Drive Mechanism

Fail-Safe with Go Call function

### Operating Environment

Outdoor  
 Extreme outdoor \*\*  
 Indoor

### Optional Accessories

Heel protector \*  
 RFID reader bracket  
 Identification or Ticket terminal bracket  
 Access Light including bracket  
 Lane Light including bracket  
 Ceiling Light  
 Canopy LT  
 USB convertor / Ethernet convertor  
 EasyTouch / TouchPanel  
 T-MON SW  
 Power supply backup  
 Alternative surface finishes  
 WAV Player

## REXON ERA 3 GS

## REXON ERA DUO 3 GS

## REXON ERA 3 GS-U

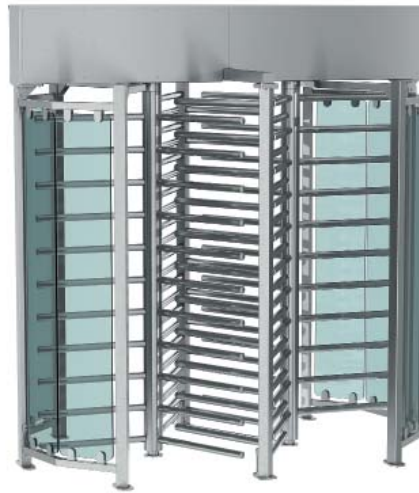

<b>Barrier type</b>	11 straight arms with black plastic covering caps $\varnothing$ 40 mm / 1.57"	11 straight arms with black plastic covering caps $\varnothing$ 40 mm / 1.57"	6 trombone style U-shaped arms $\varnothing$ 22 mm / 0.87"
<b>Unit height</b>	2 520 mm / 99.21"	2 520 mm / 99.21"	2 520 mm / 99.21"
<b>Unit width</b>	1 540 mm / 60.63"	2 360 mm / 92.91"	1 540 mm / 60.63"
<b>Passage height</b>	2 100 mm / 82.68"	2 100 mm / 82.68"	2 100 mm / 82.68"
<b>Passage width</b>	644 mm / 25.35"	644 mm / 25.35"	644 mm / 25.35"
<b>Frame</b>	hot-dip zinc galvanized powder coated finish in RAL 7040	hot-dip zinc galvanized powder coated finish in RAL 7040	hot-dip zinc galvanized powder coated finish in RAL 7040
<b>Top panel</b>	hot-dip zinc galvanized	hot-dip zinc galvanized	hot-dip zinc galvanized
<b>Barrier</b>	hot-dip zinc galvanized	hot-dip zinc galvanized	polished stainless steel
<b>Side panels</b>	laminated glass	laminated glass	laminated glass

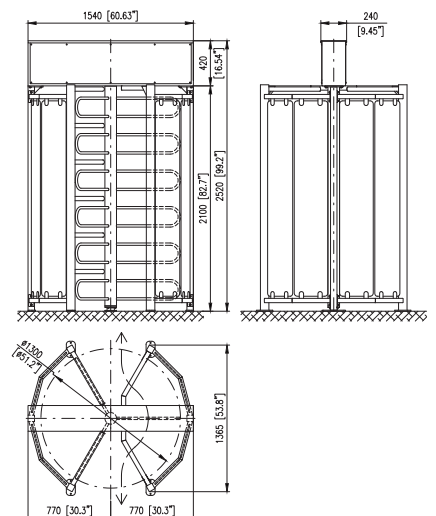
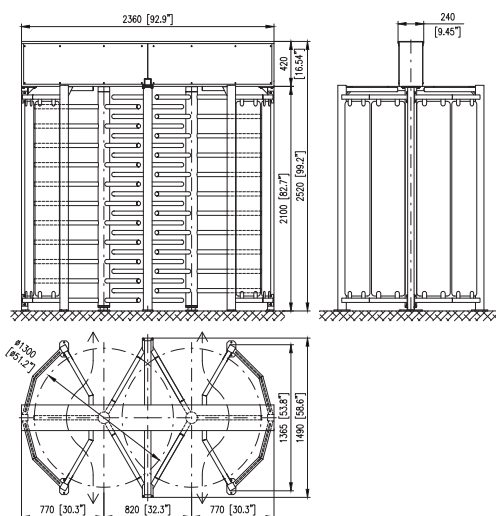
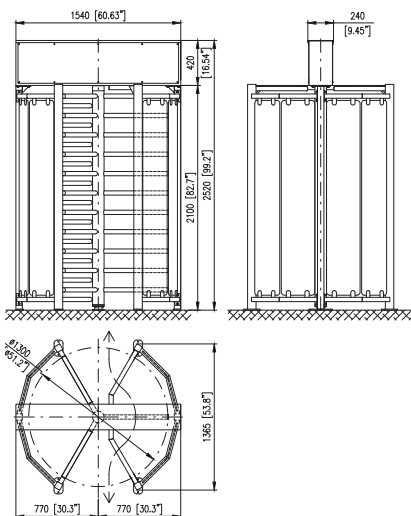



## REXON ERA 3 GATE-BIKE

### Type

REXON ERA 3 GATE-BIKE

Full height motorized turnstile with integrated bicycle gate  
3 door wings  
Bi-directional passage

### Drive Mechanism

Fail-Safe with Go Call function

### Operating Environment

Outdoor  
Extreme outdoor \*  
Indoor

### Optional Accessories

Induction loop system for detection of bicycles and scooters  
Heel protector  
RFID reader bracket  
Identification or Ticket terminal bracket  
Access Light including bracket  
Lane Light including bracket  
Ceiling Light  
Canopy LT  
USB convertor / Ethernet convertor  
EasyTouch / TouchPanel  
T-MON SW  
Power supply backup  
Alternative surface finishes  
WAV Player



<b>Barrier type</b>	11 straight arms with black plastic covering caps $\varnothing$ 40 mm / 1.57"
<b>Unit height</b>	2 520 mm / 9.21"
<b>Unit width</b>	2 230 mm / 87.80"
<b>Unit width for scooters</b>	2 520 mm / 99.21"
<b>Passage height</b>	2 100 mm / 82.68"
<b>Passage width</b>	644 mm / 25.35"
<b>Passage width for bicycles</b>	540 mm / 21.26"
<b>Passage width for scooters</b>	730 mm / 28.74"
<b>Frame</b>	hot-dip zinc galvanized
<b>Top panel</b>	hot-dip zinc galvanized, powder coated finish in RAL 7040
<b>Barrier</b>	hot-dip zinc galvanized

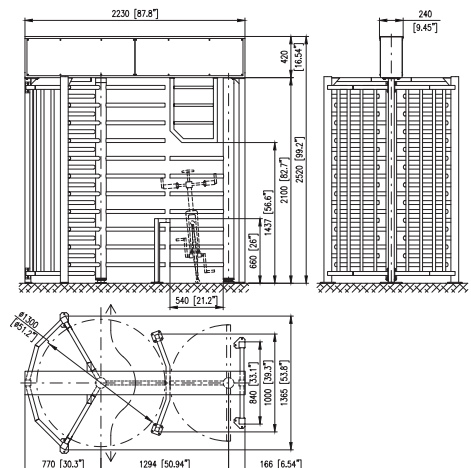

\* As an option





## REXON ERA 4

### Type

REXON ERA 4

Full height motorized turnstile  
4 door wings  
Bi-directional passage

### Drive Mechanism

Fail-Safe with Go Call function

### Operating Environment

Outdoor  
Extreme outdoor \*  
Indoor

### Optional Accessories

Heel protector  
RFID reader bracket  
Identification or Ticket terminal bracket  
Access Light including bracket  
Lane Light including bracket  
Ceiling Light  
Canopy LT  
USB convertor / Ethernet convertor  
EasyTouch / TouchPanel  
T-MON SW  
Power supply backup  
Alternative surface finishes  
WAV Player



<b>Barrier type</b>	11 straight arms with black plastic covering caps $\varnothing$ 40 mm / 1.57"
<b>Unit height</b>	2 520 mm / 99.21"
<b>Unit width</b>	1 540 mm / 60.63"
<b>Passage height</b>	2 100 mm / 82.68"
<b>Passage width</b>	535 mm / 21.06"
<b>Frame</b>	hot-dip zinc galvanized
<b>Top panel</b>	hot-dip zinc galvanized, powder coated finish in RAL 7040
<b>Barrier</b>	hot-dip zinc galvanized

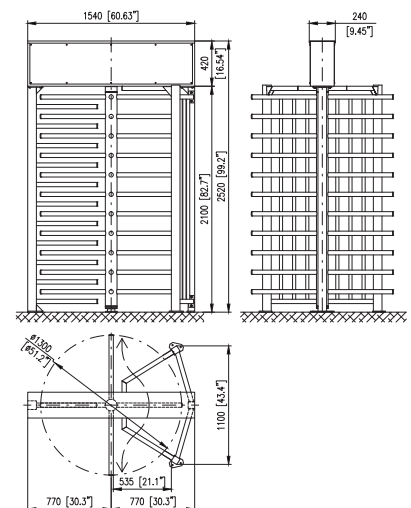

\* As an option



## REXON ERA 4-LE REXON ERA DUO 4-LE

### Type

REXON ERA 4-LE  
REXON ERA DUO 4-LE

Full height motorized turnstile with entry / exit side panels  
4 door wings  
Bi-directional passage

### Drive Mechanism

Fail-Safe with Go Call function

### Operating Environment

Outdoor  
Extreme outdoor \*  
Indoor

### Optional Accessories

Heel protector  
RFID reader bracket  
Identification or Ticket terminal bracket  
Access Light including bracket  
Lane Light including bracket  
Ceiling Light  
Canopy LT  
USB convertor / Ethernet convertor  
EasyTouch / TouchPanel  
T-MON SW  
Power supply backup  
Alternative surface finishes  
WAV Player

\* As an option

## REXON ERA 4-LE



<b>Barrier type</b>	11 straight arms with black plastic covering caps ø 40 mm / 1.57"
<b>Unit height</b>	2 520 mm / 99.21"
<b>Unit width</b>	1 350 mm / 53.15"
<b>Passage height</b>	2 100 mm / 82.68"
<b>Passage width</b>	550 mm / 21.63"
<b>Frame</b>	hot-dip zinc galvanized
<b>Top panel</b>	hot-dip zinc galvanized, powder coated finish in RAL 7040
<b>Barrier</b>	hot-dip zinc galvanized

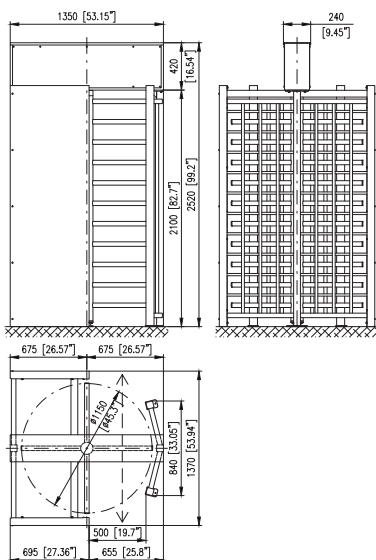

## REXON ERA DUO 4-LE



<b>Barrier type</b>	11 straight arms with black plastic covering caps ø 40 mm / 1.57"
<b>Unit height</b>	2 520 mm / 99.21"
<b>Unit width</b>	2 050 mm / 80.71"
<b>Passage height</b>	2 100 mm / 82.68"
<b>Passage width</b>	550 mm / 21.63"
<b>Frame</b>	hot-dip zinc galvanized
<b>Top panel</b>	hot-dip zinc galvanized, powder coated finish in RAL 7040
<b>Barrier</b>	hot-dip zinc galvanized

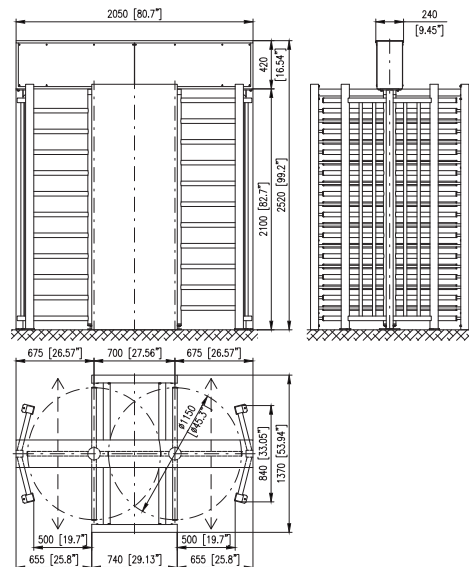



## REXON GLASS 1600 / 1800

### Type

REXON GLASS 1600  
REXON GLASS 1800

Revolving glass full-height turnstile  
3 door wings  
Bi-directional passage

### Drive Mechanism

Fail-Safe with Go Call function

### Operating Environment

Indoor

### Optional Accessories

Push-Bars on glass wing  
RFID reader bracket  
Identification or Ticket terminal bracket  
Access Light including bracket  
Lane Light including bracket  
Ceiling Light  
USB convertor / Ethernet convertor  
EasyTouch / TouchPanel  
T-MON SW  
Power supply backup  
Alternative surface finishes  
WAV Player

## REXON GLASS 1600



<b>Barrier type</b>	laminated glass
<b>Unit height</b>	2 450 mm / 96.46"
<b>Unit width</b>	1 610 mm / 63.39"
<b>Passage height</b>	2 050 mm / 82.68"
<b>Passage width</b>	705 mm / 27.76"
<b>Frame</b>	brushed stainless steel AISI 304
<b>Top panel</b>	brushed stainless steel AISI 304
<b>Barrier</b>	10 mm / 0.39" tempered laminated glass

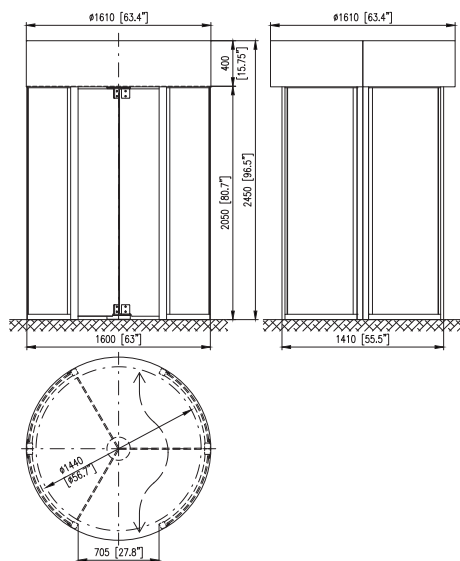

## REXON GLASS 1800



<b>Barrier type</b>	laminated glass
<b>Unit height</b>	2 450 mm / 96.46"
<b>Unit width</b>	1 810 mm / 71.26"
<b>Passage height</b>	2 050 mm / 82.68"
<b>Passage width</b>	805 mm / 31.69"
<b>Frame</b>	brushed stainless steel AISI 304
<b>Top panel</b>	brushed stainless steel AISI 304
<b>Barrier</b>	10 mm / 0.39" tempered laminated glass

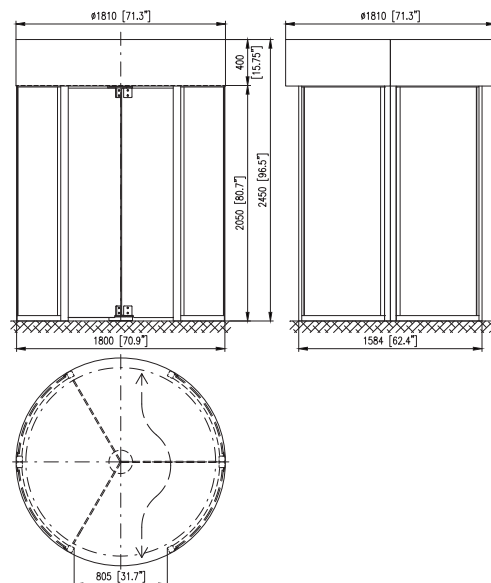



## REXON BASIC 3

### Type

REXON BASIC 3

Full-height motorized turnstile  
3 door wings  
Bi-directional passage

### Drive Mechanism

Fail-Safe with Go Call function

### Operating Environment

Outdoor  
Indoor

### Optional Accessories

Heel protector  
RFID reader bracket  
Identification or Ticket terminal bracket  
Access Light including bracket  
Lane Light including bracket  
Ceiling Light  
USB convertor / Ethernet convertor  
EasyTouch / TouchPanel  
T-MON SW  
Power supply backup  
Alternative surface finishes  
WAV Player



<b>Barrier type</b>	8 straight arms with black plastic covering caps $\varnothing$ 40 mm / 1.57"
<b>Unit height</b>	2 435 mm / 95.87"
<b>Unit width</b>	1 385 mm / 54.53"
<b>Passage height</b>	2 040 mm / 80.31"
<b>Passage width</b>	648 mm / 25.51"
<b>Frame</b>	hot-dip zinc galvanized
<b>Top panel</b>	hot-dip zinc galvanized
<b>Barrier</b>	hot-dip zinc galvanized

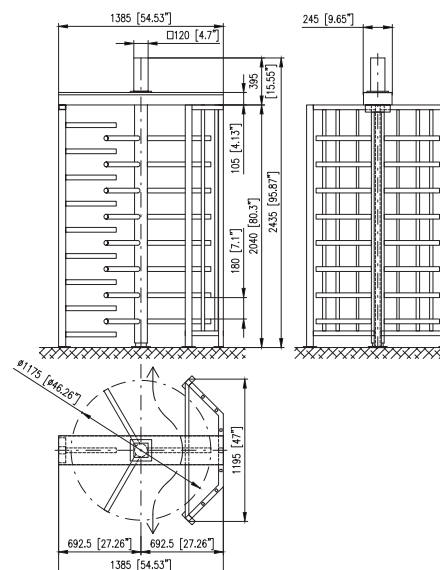



# Gate

Full Height Gates



# GATE DEA

# GATE DEA DUO

# GATE DEA-U

# GATE DEA DUO-U

## Type

GATE DEA  
GATE DEA DUO  
GATE DEA-U  
GATE DEA DUO-U

Motorized full height gate  
Gate door barrier  
Bi-directional passage

## Drive Mechanism

Fail-Safe

## Operating Environment

Outdoor  
Indoor

## Optional Accessories

Heel protector \*  
RFID reader bracket  
Identification or Ticket terminal bracket  
Access Light including bracket  
lane Light including bracket  
Ceiling Light  
USB convertor / Ethernet convertor  
EasyTouch / TouchPanel  
T-MON SW  
Power supply backup  
Alternative surface finishes

## GATE DEA

## GATE DEA DUO

<b>Barrier type</b>	11 straight arms with black plastic covering caps ø 40 mm / 1.57"	
<b>Unit height</b>	2 465 mm / 97.05"	2 465 mm / 97.05"
<b>Unit width</b>	1 450 mm / 57.09"	2 570 mm / 101.18"
<b>Passage height</b>	2 100 mm / 82.68"	2 100 mm / 82.68"
<b>Passage width</b>	max. 920 mm / 36.22"	max. 1 800 mm / 70.87"
<b>Casework</b>	hot-dip zinc galvanized, powder coated finish in RAL colour per specs	
<b>Barrier</b>	hot-dip zinc galvanized	

## GATE DEA-U

## GATE DEA DUO-U

<b>Barrier type</b>	6 trombone style (U-shaped) arms ø 22 mm / 0.87"	
<b>Unit height</b>	2 465 mm / 97.05"	2 465 mm / 97.05"
<b>Unit width</b>	1 450 mm / 57.09"	2 570 mm / 101.18"
<b>Passage height</b>	2 100 mm / 82.68"	2 100 mm / 82.68"
<b>Passage width</b>	max. 920 mm / 36.22"	max. 1 800 mm / 70.87"
<b>Casework</b>	hot-dip zinc galvanized, powder coated finish in RAL colour per specs	
<b>Barrier</b>	polished stainless steel	

\* Not available for version with U-shaped arms.



## GATE DEA

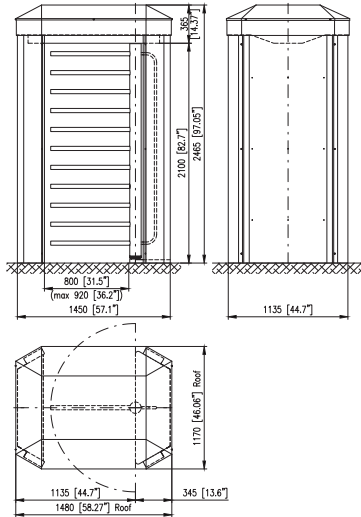

## GATE DEA DUO

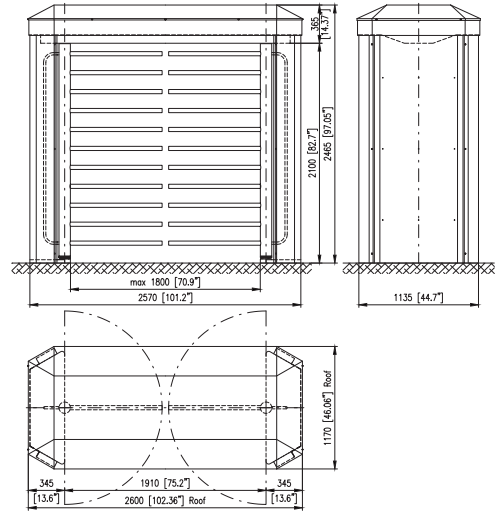

## GATE DEA-U

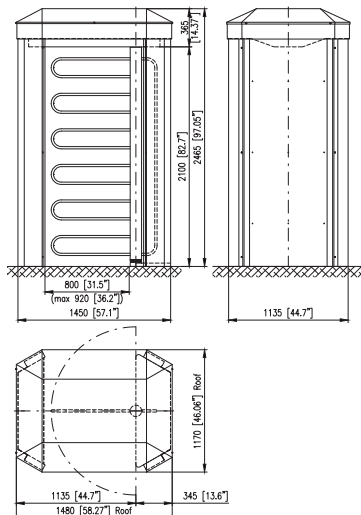

## GATE DEA DUO-U

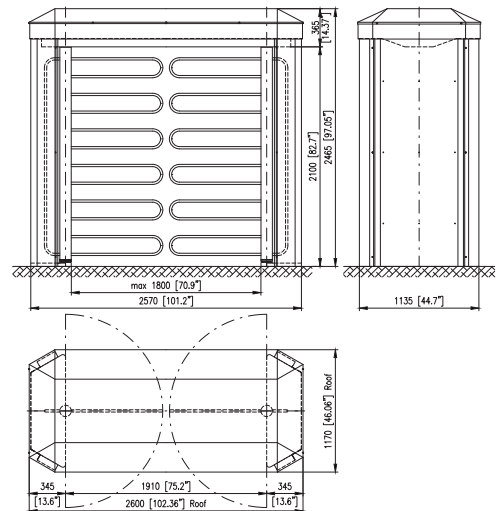



# GATE ERA GATE ERA DUO GATE ERA-U GATE ERA DUO-U

## Type

GATE ERA  
GATE ERA DUO  
GATE ERA-U  
GATE ERA DUO-U

Motorized full height gate  
Gate door barrier  
Bi-directional passage

## Drive Mechanism

Fail-Safe

## Operating Environment

Outdoor / Extreme outdoor\*\*  
Indoor

## Optional Accessories

Heel protector \*  
RFID reader bracket  
Identification or Ticket terminal bracket  
Access Light / Lane Light including bracket  
Extreme outdoor package  
Ceiling Light  
Canopy LT  
USB convertor / Ethernet convertor  
EasyTouch / TouchPanel / T-MON SW  
Power supply backup  
Alternative surface finishes  
WAV Player

## GATE ERA

## GATE ERA DUO

<b>Barrier type</b>	11 straight arms with black plastic covering caps ø 40 mm / 1.57"	
<b>Unit height</b>	2 520 mm / 99.21"	2 520 mm / 99.21"
<b>Unit width</b>	1 020 mm / 40.16"	2 090 mm / 82.28"
<b>Passage height</b>	2 100 mm / 82.68"	2 100 mm / 82.68"
<b>Passage width</b>	max. 920 mm / 36.22"	max. 1 800 mm / 70.87"
<b>Frame</b>	hot-dip zinc galvanized	
<b>Top panel</b>	hot-dip zinc galvanized, powder coated finish in RAL 7040	
<b>Barrier</b>	hot-dip zinc galvanized	

## GATE ERA-U

## GATE ERA DUO-U

<b>Barrier type</b>	6 trombone style (U-shaped) arms ø 22 mm / 0.87"	
<b>Unit height</b>	2 520 mm / 99.21"	2 520 mm / 99.21"
<b>Unit width</b>	1 020 mm / 40.16"	2 090 mm / 82.28"
<b>Passage height</b>	2 100 mm / 82.68"	2 100 mm / 82.68"
<b>Passage width</b>	max. 920 mm / 36.22"	max. 1 800 mm / 70.87"
<b>Frame</b>	hot-dip zinc galvanized	
<b>Top panel</b>	hot-dip zinc galvanized, powder coated finish in RAL 7040	
<b>Barrier</b>	polished stainless steel	

## GATE ERA

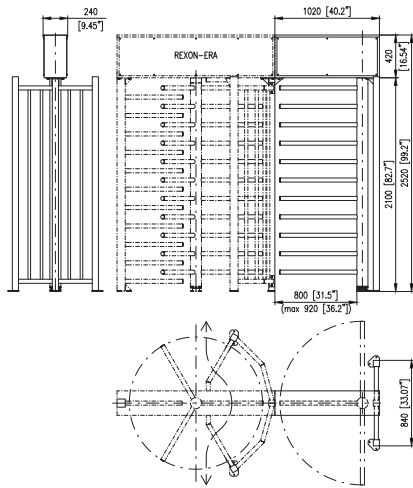

## GATE ERA DUO

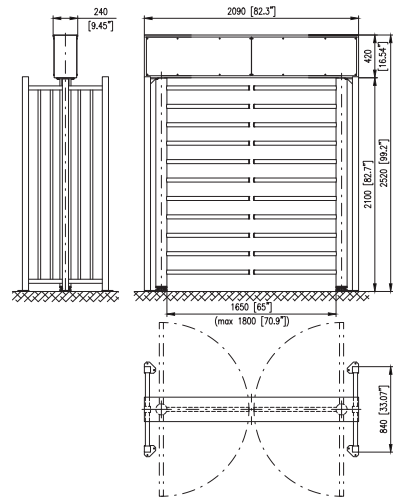

## GATE ERA-U

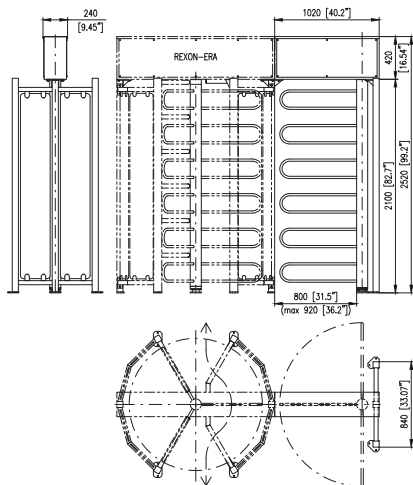

## GATE ERA DUO-U

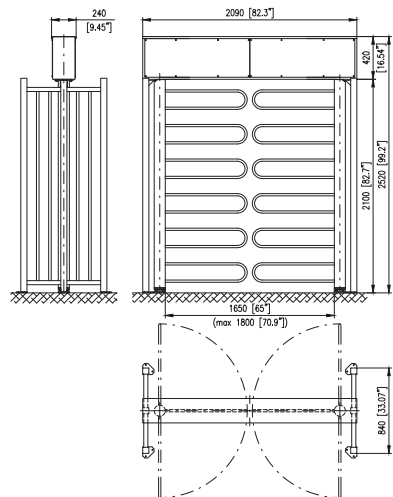



## GATE ERA LE

## GATE ERA DUO LE

## GATE ERA LE-U

## GATE ERA DUO LE-U

### Type

GATE ERA LE  
GATE ERA DUO LE  
GATE ERA LE-U  
GATE ERA DUO-LE-U

Motorized full height gate with entry/exit side panels  
Gate door barrier  
Bi-directional passage

### Drive Mechanism

Fail-Safe

### Operating Environment

Outdoor / Extreme outdoor\*\*  
Indoor

### Optional Accessories

Heel protector\*  
RFID reader bracket  
Identification or Ticket terminal bracket  
Access Light / Lane Light including bracket  
Extreme outdoor package  
Ceiling Light  
Canopy LT  
USB convertor / Ethernet convertor  
EasyTouch / TouchPanel / T-MON SW  
Power supply backup  
Alternative surface finishes  
WAV Player

	GATE ERA LE	GATE ERA DUO LE
<b>Barrier type</b>	11 straight arms with black plastic covering caps ø 40 mm / 1.57"	
<b>Unit height</b>	2 520 mm / 99.21"	2 520 mm / 99.21"
<b>Unit width</b>	1 240 mm / 48.82"	2 410 mm / 94.88"
<b>Passage height</b>	2 100 mm / 82.68"	2 100 mm / 82.68"
<b>Passage width</b>	max. 920 mm / 36.22"	max 1 800 mm / 70.87"
<b>Frame</b>	hot-dip zinc galvanized	
<b>Top panel</b>	hot-dip zinc galvanized, powder coated finish in RAL 7040	
<b>Barrier</b>	hot-dip zinc galvanized	

	GATE ERA LE-U	GATE ERA DUO LE-U
<b>Barrier type</b>	6 trombone style (U-shaped) arms ø 22 mm / 0.87"	
<b>Unit height</b>	2 520 mm / 99.21"	2 520 mm / 99.21"
<b>Unit width</b>	1 240 mm / 48.82"	2 410 mm / 94.88"
<b>Passage height</b>	2 100 mm / 82.68"	2 100 mm / 82.68"
<b>Passage width</b>	max. 920 mm / 36.22"	max 1 800 mm / 70.87"
<b>Frame</b>	hot-dip zinc galvanized	
<b>Top panel</b>	hot-dip zinc galvanized, powder coated finish in RAL 7040	
<b>Barrier</b>	polished stainless steel	

## GATE ERA LE

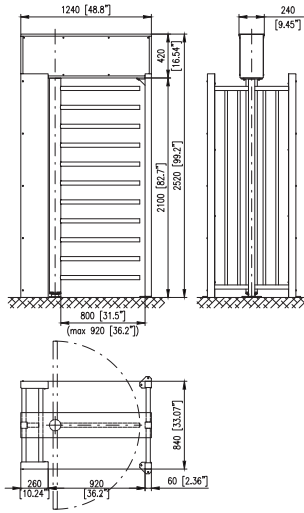

## GATE ERA DUO LE

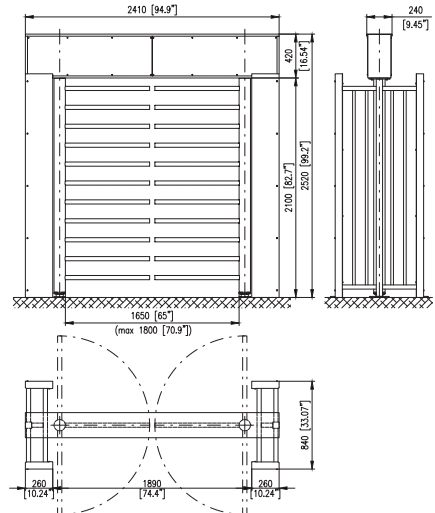

## GATE ERA LE-U

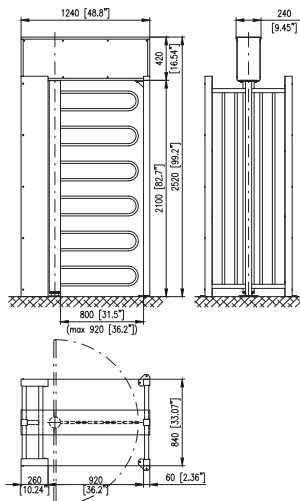

## GATE ERA DUO LE-U

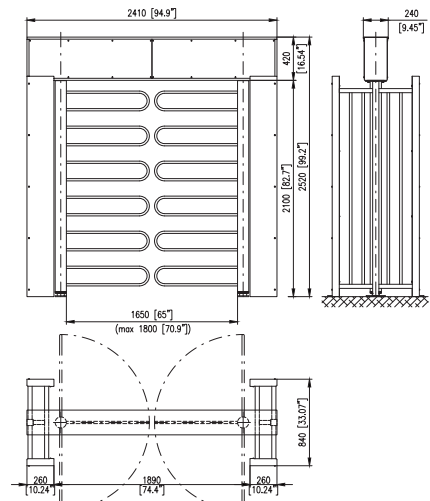

# Turnstile Model REXON



	DEA 3	DEA 3-U	DEA DUO 3	DEA 3 GATE-BIKE	DEA 3 GATE-BIKE-U	DEA 3 GATE-FULL	DEA 3 GATE-FULL-U	DEA 4
<b>Type</b>								
Full-height motorized turnstile / Full-height motorized turnstile with side panels	- / •	- / •	- / •	- / •	- / •	- / •	- / •	- / •
Single version / Double version / Roof	• / - / •	• / - / •	- / • / •	• / - / •	• / - / •	• / - / •	• / - / •	• / - / •
Integrated bicycle gate / Integrated full-height gate	- / -	- / -	- / -	• / -	• / -	- / •	- / •	- / -
<b>Barrier type</b>								
3 doors barrier / 4 doors barrier	• / -	• / -	• / -	• / -	• / -	• / -	• / -	- / •
11 straight arms [1] / 6 trombone style (U-shaped) arms [2]	• / -	- / •	• / -	• / -	- / •	• / -	- / •	• / -
<b>Dimensions</b>								
Unit height in mm / inches	2 465 / 9705*	2 465 / 9705*	2 465 / 9705*	2 465 / 9705*	2 465 / 9705*	2 465 / 9705*	2 465 / 9705*	2 550 / 100.39*
Unit width in mm / inches	1 400 / 55.12*	1 400 / 55.12*	2 520 / 99.21*	2 330 / 91.73*	2 330 / 91.73*	2 590 / 101.97*	2 590 / 101.97*	1 440 / 56.69*
Passage height in mm / inches	2 100 / 82.68*	2 100 / 82.68*	2 100 / 82.68*	2 100 / 82.68*	2 100 / 82.68*	2 100 / 82.68*	2 100 / 82.68*	2 100 / 82.68*
Passage width in mm / inches	620 / 24.41*	620 / 24.41*	620 / 24.41*	620 / 24.41*	620 / 24.41*	620 / 24.41*	620 / 24.41*	550 / 21.65*
Passage width for bike or full-height gate in mm / inches [7]	-	-	-	540 / 21.26*	540 / 21.26*	900 / 35.43*	900 / 35.43*	-
<b>Standard material</b>								
ERA or Basic version - frame: hot dip zinc galvanized	-	-	-	-	-	-	-	-
DEA version - casework: hot dip zinc galvanized with RAL powder coated finish / stainless steel	• / -	• / -	• / -	• / -	• / -	• / -	• / -	- / •
GLASS version: stainless steel frame with glass side panels	-	-	-	-	-	-	-	-
Top panel or Roof: hot dip zinc galvanized with RAL powder coated finish / stainless steel	• / -	• / -	• / -	• / -	• / -	• / -	• / -	- / •
Barrier: hot dip zinc galvanized with plastic covering caps / polished stainless steel	• / -	- / •	• / -	• / -	- / •	• / -	- / •	- / •
<b>Safety features</b>								
Emergency (Fire Alarm) input / Go Call function	• / •	• / •	• / •	• / •	• / •	• / •	• / •	• / •
Induction loop system for detection of bicycles and scooters	-	-	-	•	•	-	-	-
<b>Communication interface</b>								
Relay Inputs / Outputs	• / •	• / •	• / •	• / •	• / •	• / •	• / •	• / •
RS485 / USB / Ethernet	• / • / •	• / • / •	• / • / •	• / • / •	• / • / •	• / • / •	• / • / •	• / • / •
<b>Drive mechanism</b>								
Fail-Safe [4]	•	•	•	•	•	•	•	•
<b>Operating environment</b>								
Indoor / Outdoor	• / •	• / •	• / •	• / •	• / •	• / •	• / •	• / •
Extreme weather conditions *	-	-	-	-	-	-	-	-
<b>Power supply input</b>								
24 VAC / 230 VAC [6]	• / •	• / •	• / •	• / •	• / •	• / •	• / •	• / •
Backup battery *	•	•	•	•	•	•	•	•
<b>Optional features</b>								
Heel protector	•	-	•	•	-	•	-	•
RFID reader bracket / Identification or Ticket terminal bracket	• / •	• / •	• / •	• / •	• / •	• / •	• / •	• / •
Access Light / Lane Light including bracket	• / •	• / •	• / •	• / •	• / •	• / •	• / •	• / •
Ceiling Light	•	•	•	•	•	•	•	•
Canopy LT	-	-	-	-	-	-	-	-
<b>Optional remote control systems</b>								
Remote control console (EasyTouch, TouchPanel)	•	•	•	•	•	•	•	•
TMON software application (remote control from any PC) / Passage Scheduler (automatic planner)	• / •	• / •	• / •	• / •	• / •	• / •	• / •	• / •
<b>Optional finishes</b>								
ERA or Basic version - frame and top panel: RAL powder coated finish / stainless steel	- / -	- / -	- / -	- / -	- / -	- / -	- / -	- / -
DEA version - casework and roof: stainless steel	•	•	•	•	•	•	•	•
Barrier: RAL powder coated finish / brushed stainless steel	• / •	[5]	• / •	• / •	[5]	• / •	[5]	• / •

• Available  
- Not available

\* Optional accessories  
[1] Ø 40 mm / 1.57" with plastic covering caps

[2] Ø 22 mm / 0.87"  
[3] 8 straight bars

[4] Free-to-move without power  
[5] When U-shaped arms only polished stainless steel



DEA DUO 4	ERA 3	ERA DUO 3	ERA 3 GS	ERA DUO 3 GS	ERA 3 GS-U	ERA 3 GATE-BIKE	ERA 4	ERA 4-LE	ERA DUO 4-LE	GLASS 1600	Glass 1800	BASIC 3
-/•	•/-	•/-	-/•	-/•	-/•	•/-	•/-	•/-	•/-	-/•	-/•	•/-
-/•/•	•/-/-	-/•/-	•/-/-	-/•/-	•/-/-	•/-/-	•/-/-	•/-/-	-/•/-	•/-/•	•/-/•	•/-/-
-/-	-/-	-/-	-/-	-/-	-/-	•/-	-/-	-/-	-/-	-/-	-/-	-/-
-/•	•/-	•/-	•/-	•/-	•/-	•/-	-/•	-/•	-/•	•/-	•/-	•/-
•/-	•/-	•/-	•/-	•/-	-/•	•/-	•/-	•/-	•/-	-	-	[3]
2 550 / 100.39"	2 520 / 99.21"	2 520 / 99.21"	2 520 / 99.21"	2 520 / 99.21"	2 520 / 99.21"	2 520 / 99.21"	2 520 / 99.21"	2 520 / 99.21"	2 520 / 99.21"	2 450 / 96.46"	2 450 / 96.46"	2 435 / 95.87"
2 235 / 88.00"	1 540 / 60.63"	2 360 / 92.91"	1 540 / 60.63"	2 360 / 92.91"	1 540 / 60.63"	2 230 / 87.80"	1 540 / 60.63"	1 350 / 53.15"	2 050 / 80.71"	1 610 / 63.39"	1 810 / 71.26"	1 385 / 54.53"
2 100 / 82.68"	2 100 / 82.68"	2 100 / 82.68"	2 100 / 82.68"	2 100 / 82.68"	2 100 / 82.68"	2 100 / 82.68"	2 100 / 82.68"	2 100 / 82.68"	2 100 / 82.68"	2 050 / 80.71"	2 050 / 80.71"	2 040 / 80.31"
550 / 21.65"	644 / 25.35"	644 / 25.35"	644 / 25.35"	644 / 25.35"	644 / 25.35"	644 / 25.35"	535 / 21.06"	550 / 21.63"	550 / 21.63"	705 / 27.76"	805 / 31.69"	648 / 25.51"
-	-	-	-	-	-	540 / 21.26"	-	-	-	-	-	-
-	•	•	•	•	•	•	•	•	•	-	-	•
-/•	-/-	-/-	-/-	-/-	-/-	-/-	-/-	-/-	-/-	-/-	-/-	-/-
-	-	-	•	•	•	-	-	-	-	•	•	-
-/•	•/-	•/-	•/-	•/-	•/-	•/-	•/-	•/-	•/-	-/•	-/•	•/-
-/•	•/-	•/-	•/-	•/-	-/•	•/-	•/-	•/-	•/-	-/-	-/-	•/-
•/•	•/•	•/•	•/•	•/•	•/•	•/•	•/•	•/•	•/•	•/•	•/•	•/•
-	-	-	-	-	-	•	-	-	-	-	-	-
•/•	•/•	•/•	•/•	•/•	•/•	•/•	•/•	•/•	•/•	•/•	•/•	•/•
•/•/•	•/•/•	•/•/•	•/•/•	•/•/•	•/•/•	•/•/•	•/•/•	•/•/•	•/•/•	•/•/•	•/•/•	•/•/•
•	•	•	•	•	•	•	•	•	•	•	•	•
•/•	•/•	•/•	•/•	•/•	•/•	•/•	•/•	•/•	•/•	•/•	•/•	•/•
-	•	•	•	•	•	•	•	•	•	-	-	-
•/•	•/•	•/•	•/•	•/•	•/•	•/•	•/•	•/•	•/•	•/•	•/•	•/•
•	•	•	•	•	•	•	•	•	•	•	•	•
•	•	•	•	•	-	•	•	•	•	-	-	•
•/•	•/•	•/•	•/•	•/•	•/•	•/•	•/•	•/•	•/•	•/•	•/•	•/•
•/•	•/•	•/•	•/•	•/•	•/•	•/•	•/•	•/•	•/•	•/•	•/•	•/•
•	•	•	•	•	•	•	•	•	•	•	•	•
-	•	•	•	•	•	•	•	•	•	-	-	-
•	•	•	•	•	•	•	•	•	•	•	•	•
•/•	•/•	•/•	•/•	•/•	•/•	•/•	•/•	•/•	•/•	•/•	•/•	•/•
-/-	•/•	•/•	•/•	•/•	•/•	•/•	•/•	•/•	•/•	-/-	-/-	•/•
•	-	-	-	-	-	-	-	-	-	-	-	-
•/•	•/•	•/•	•/•	•/•	[5]	•/•	•/•	•/•	•/•	-	-	•/•

[6] 230 VAC for Raxon-DEA turnstiles is available just in stainless steel option  
 [7] Max passage width for full-height gate: 920 mm / 36.22"

# Turnstile Model GATE

GATE DEA



GATE DEA DUO



GATE DEA-U



GATE DEA DUO-U



Type	GATE DEA	GATE DEA DUO	GATE DEA-U	GATE DEA DUO-U
Motorized full height gate	•	•	•	•
Single version / Double version	• / -	- / •	• / -	- / •
<b>Barrier type</b>				
11 straight arms [1] / 6 trombone style (U-shaped ) arms [2]	• / -	• / -	- / •	- / •
<b>Dimensions</b>				
Unit height in mm / inches	2 465 / 9705*	2 465 / 9705*	2 465 / 9705*	2 465 / 9705*
Unit width in mm / inches for passage width single 900 mm / 35.43* / double 1650 mm / 64.96*	1 450 / 5709*	2 570 / 101.18*	1 450 / 5709*	2 570 / 101.18*
Passage height in mm / inches	2 100 / 82.68*	2 100 / 82.68*	2 100 / 82.68*	2 100 / 82.68*
Max passage width in mm / inches	max. 920 / 36.22*	max. 1 800 / 70.87*	max. 920 / 36.22*	max. 1 800 / 70.87*
<b>Standard material</b>				
ERA version - frame: hot dip zinc galvanized	-	-	-	-
DEA version - casework: hot dip zinc galvanized with RAL powder coated finish	•	•	•	•
Top panel (roof): hot dip zinc galvanized with RAL powder coated finish	•	•	•	•
Barrier: hot dip zinc galvanized with plastic covering caps / polished stainless steel	• / -	• / -	- / •	- / •
<b>Safety features</b>				
Emergency (Fire Alarm) input / Go Call function	• / -	• / -	• / -	• / -
Induction loop system for detection of bicycles and scooters	-	-	-	-
<b>Communication interface</b>				
Relay Inputs / Outputs	• / •	• / •	• / •	• / •
RS485 / USB / Ethernet	• / • / •	• / • / •	• / • / •	• / • / •
<b>Drive mechanism</b>				
Fail-Safe [3]	•	•	•	•
<b>Operating environment</b>				
Indoor / Outdoor	• / •	• / •	• / •	• / •
Extreme weather conditions *	-	-	-	-
<b>Power supply input</b>				
24 VAC / 230 VAC [4]	• / •	• / •	• / •	• / •
Backup battery *	•	•	•	•
<b>Optional features</b>				
Heel protector	•	•	-	-
RFID reader bracket / Identification or Ticket terminal bracket	• / •	• / •	• / •	• / •
Access Light / Lane Light including bracket	• / •	• / •	• / •	• / •
Ceiling Light	•	•	•	•
Canopy LT	-	-	-	-
<b>Optional remote control systems</b>				
Remote control console (EasyTouch, TouchPanel)	•	•	•	•
TMON software application (remote control from any PC) / Passage Scheduler (automatic planner)	• / •	• / •	• / •	• / •
<b>Optional finishes</b>				
ERA version - frame and top panel: RAL powder coated finish / stainless steel	-	-	-	-
DEA version - casework and roof: RAL powder coated finish / stainless steel	• / •	• / •	• / •	• / •
Barrier: RAL powder coated finish / brushed stainless steel	• / •	• / •	[5]	[5]

• Available  
- Not available

\* Optional accessories  
[1] ø 40 mm / 1.57" with plastic covering caps

[2] ø 22 mm / 0.87"  
[3] Free-to-move without power

[4] 230 VAC for REXON-DEA turnstiles is available just in stainless steel option  
[5] When U-shaped arms only polished stainless steel



GATE ERA



GATE ERA DUO



GATE ERA-U



GATE ERA DUO-U



GATE ERA LE



GATE ERA DUO LE



GATE ERA LE-U



GATE ERA DUO LE-U



•	•	•	•	•	•	•	•
•/-	-/•	•/-	-/•	•/-	-/•	•/-	-/•
•/-	•/-	-/•	-/•	•/-	•/-	-/•	-/•
2 520 / 99.21"	2 520 / 99.21"	2 520 / 99.21"	2 520 / 99.21"	2 520 / 99.21"	2 520 / 99.21"	2 520 / 99.21"	2 520 / 99.21"
1 020 / 40.16"	2 090 / 82.28"	1 020 / 40.16"	2 090 / 82.28"	1 240 / 48.82"	2 410 / 94.88"	1 240 / 48.82"	2 410 / 94.88"
2 100 / 82.68"	2 100 / 82.68"	2 100 / 82.68"	2 100 / 82.68"	2 100 / 82.68"	2 100 / 82.68"	2 100 / 82.68"	2 100 / 82.68"
max. 920 / 36.22"	max. 1 800 / 70.87"	max. 920 / 36.22"	max. 1 800 / 70.87"	max. 920 / 36.22"	max. 1 800 / 70.87"	max. 920 / 36.22"	max. 1 800 / 70.87"
•	•	•	•	•	•	•	•
-	-	-	-	-	-	-	-
•	•	•	•	•	•	•	•
•/-	•/-	-/•	-/•	•/-	•/-	-/•	-/•
•/-	•/-	•/-	•/-	•/-	•/-	•/-	•/-
-	-	-	-	-	-	-	-
•/•	•/•	•/•	•/•	•/•	•/•	•/•	•/•
•/•/•	•/•/•	•/•/•	•/•/•	•/•/•	•/•/•	•/•/•	•/•/•
•	•	•	•	•	•	•	•
•/•	•/•	•/•	•/•	•/•	•/•	•/•	•/•
•	•	•	•	•	•	•	•
•/•	•/•	•/•	•/•	•/•	•/•	•/•	•/•
•	•	•	•	•	•	•	•
•	•	-	-	•	•	-	-
•/•	•/•	•/•	•/•	•/•	•/•	•/•	•/•
•/•	•/•	•/•	•/•	•/•	•/•	•/•	•/•
•	•	•	•	•	•	•	•
•	•	•	•	•	•	•	•
•	•	•	•	•	•	•	•
•/•	•/•	•/•	•/•	•/•	•/•	•/•	•/•
•/•	•/•	•/•	•/•	•/•	•/•	•/•	•/•
-	-	-	-	-	-	-	-
•/•	•/•	[5]	[5]	•/•	•/•	[5]	[5]

# Options & Accessories



**TMON SOFTWARE** – software application for easy remote control of the turnstiles and gates



**EASY::TOUCH** – turnstile remote control console with an intuitive graphical user interface



**TOUCH PANEL** – touch-button panel for remote control of turnstiles and gates

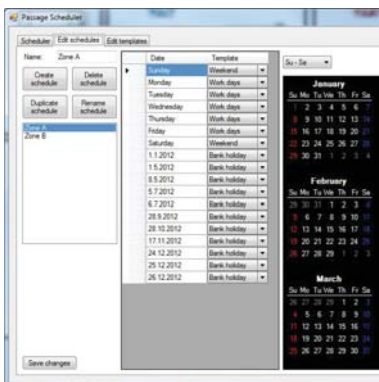

**TURNSTILE SCHEDULER** – software for automatic time programming of turnstile accessibility in each direction (TMON SW required)



**ACCESS LIGHT WITH BRACKET** – access control light with integrated RFID bracket including bracket



**LANE LIGHT** – front mounted lane accessibility light panel

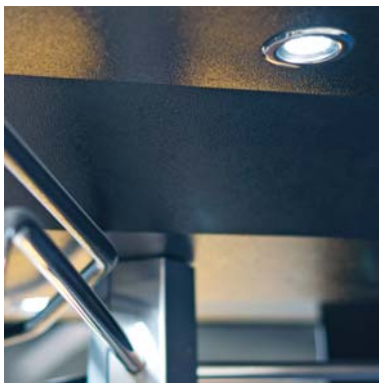

**CEILING LIGHT** – with automatic Day-On/Night-Off mode to illuminate the walkway



**HEEL PROTECTOR** – protector of straight arms made of black toughened rubber material



**RFID READER** – implementation of any RFID reader



**CANOPY LT/CANOPY LT DUO** – single version for REXON ERA / GATE ERA or duo version for REXON ERA DUO / GATE ERA DUO made from Aluminium frame and polycarbonate panels



**MOUNTING FRAME** – console suitable for REXON and GATE models for pre-installation into concreted basement



**ALTERNATIVE SURFACE FINISH** – frame, rotor, arms, central pillar or completely in stainless steel or Polyester Powder Coated



**INDUCTIVE LOOP SYSTEM** – detects bicycle or small motor-scooter in passage lane



**ALARM BUZZER** – alarm buzzer signalling unauthorized passage



**EXTREME OUTDOOR PACKAGE** – special package for outdoor application (heating module + IP protection)

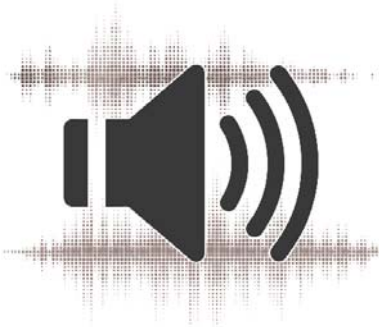

**WAV PLAYER** – sound signaling device for audio confirmation of turnstile operation mode



**REXON::TICKET** – external implementation of identification terminal



**PUSHBAR** – Push-Bars on glass wing for REXON GLASS turnstile

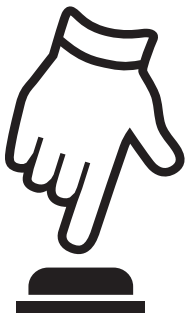

**SWITCH-BUTTON** – for manual gate control

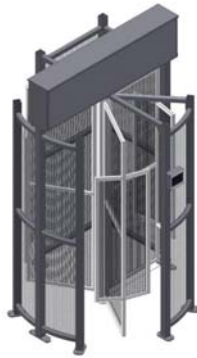

**REXON NET** – stainless steel net barriers for application where the highest level of security is required. Used in a risky environment such as laboratories, prisons, etc.



ed. VI/2018

Specifications are subject to change without prior notice.



**COMINFO, a.s.**

Nabrezi 695, 760 01 Zlin - Prstne, Czech Republic

T +420 603 151 333

cominfo@cominfo.cz

[www.cominfo.eu](http://www.cominfo.eu)

**cominfo**  
security first