

# MODUM SYSTEM

**VIDEOPHONE  
AUDIOPHONE  
VIDEO PANEL  
AUDIO PANEL  
DISTRIBUTOR  
CCTV  
UTP  
2 WIRES  
4 WIRES  
SINGLE HOUSE  
SMALL APARTMENT  
APARTMENT COMPLEX  
GUARD COMMUNICATION  
PORTER COMMUNICATION  
MULTI ACCESS  
CENTRAL MANAGEMENT  
TOTAL SECURITY  
INTEGRATION  
UNIFICATION  
EXPANSION**

One system for all requirements.

## MODUM SYSTEM FOR ALL DOOR-ENTRY SYSTEM!!

MODUM SYSTEM is a multi functional system which can be used in various door entry and surveillance systems. It has 4.3 / 7 inch MODUM VIDEOPHONE with CCTV MONITORING and total access control through MODUM PANELS and MODUM DISTRIBUTORS to connect to functional modules.

---

### Integration

MODUM SYSTEM PROVIDES NEW DOOR ENTRY SOLUTION BY INTEGRATING VARIOUS DIFFERENT FUNCTIONS :

MODUM VIDEOPHONE can provide CCTV monitoring, Video and Audio Door units that can communicate with other indoor units.

It can be also used with RFID and PIN numbers for access through MODUM PANEL.

### Unification

MODUM SYSTEM UNIFIES WIRING ENVIRONMENT :

It is possible to unify using through the exclusive distributor of MODUM SYSTEM even in the different wiring environment such as UTP / 2 WIRES / 4 WIRES.

### Expansion

MODUM SYSTEM CAN BE EXPANDED TO MEET ANY REQUIREMENTS :

- Video to Audio modules
- Handset to Hands free type design
- 4.3" to 7" monitor, etc.
- MODUM PANELS: 26 types

The MODUM VIDEOPHONE allows for up to 8 CCTV Cameras that can monitor your home as well as common residential areas like the playground, guard post, parking lot, etc. This is the first CCTV Cameras connected to videophones. This now allows users to monitor security blindspots.



4 CCTVs

Additional 4 CCTVs



Playground



Parking lot (1)



Swimming pool



Parking lot (2)



Entrance



Lobby



Guard post



Senior center

# MODUM VIDEOPHONE

## CMV-70S



7 inch Premium Full-Touch MODUM VIDEOPHONE improves house's interior class. It has enhanced security function of CCTV monitoring and security sensor and can be installed to all door entry environments from a single house to an apartment complex.

### CCTV Monitoring & Recording

- Safety check through Quad display videophone
- Up to 8 CCTV cameras and real time monitoring function at your house
- Storing image in Micro SD memory

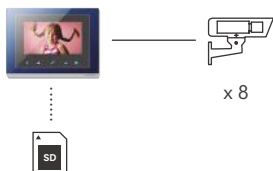

### Alarming for security

- Safety alarm function from interlocked door sensor



### 2 Door Opening

- 2 door open function through 2 door cameras
- Increasing convenience from one location

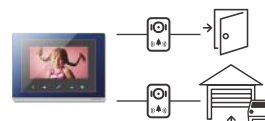

### Guard Call & Porter Call

- Calling a guard/porter with one button
- Faster communication when assistance needed





# CCTV Monitoring! Single/System Dual Application!

## MODUM VIDEOPHONE

### CMV-43SV / CMV-43S



4.3 inch Standard MODUM VIDEOPHONE improves house's interior class. It has enhanced security function of CCTV monitoring and can be installed to all door entry environments from a single house to an apartment complex.

#### CCTV Monitoring

- Safety check through videophone
- Up to 8 CCTV cameras and real time monitoring function at your house

#### 2 Door Opening

- 2 door open function through 2 door cameras
- Increasing convenience from one location

#### Guard Call & Porter Call

- Calling a guard/porter with one button
- Faster communication when assistance needed

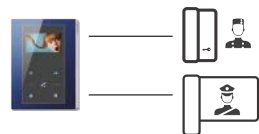
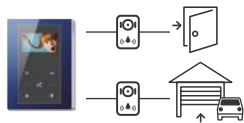

# MODUM VIDEOPHONE

## CMV-43A



4.3 inch basic MODUM VIDEOPHONE which enhance security function by CCTV monitoring. It can be installed to all door entry environments from a single house to an apartment complex.

### CCTV Monitoring

- Safety check through videophone
- Up to 8 CCTV cameras and real time monitoring function at your house

### 2 Door Opening

- 2 door open function through 2 door cameras
- Increasing convenience from one location

### Guard Call & Porter Call

- Calling a guard/porter with one button
- Faster communication when assistance needed

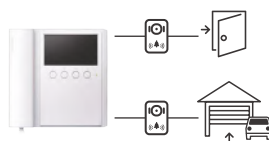

OSD



CCTV on screen display



Interphone on screen display

CCTV Monitoring 



1 Press the monitor button once



2 Press the Key button once



3 CCTV ch.1 (next channel)

Guard Call 



1 Press the Interphone button once



2 Press the GUARD button once



3 You can talk with guard when he answers the call

Porter Call 



1 Press the Interphone button once



2 Press the PORTER button once



3 You can talk with porter when he answers the call

# MODUM PANEL LINE



1 Look, 2 Sizes, 26 types of MODUM PANELS. It is available for various house types and system environments. With integrated access control features, enjoy your life safely and conveniently.

### Access Control

Providing 2ways access control function

- PIN numbers with ten-key
- RFID card

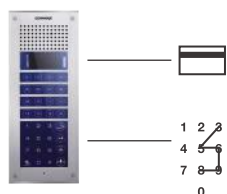

### 4 Ways Communication

Simple way to call a house

- Direct button call
- Household number call
- Guard call
- Name search

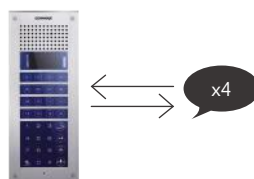

### 26 Different Options

1 Look , 2 Sizes , 26 types of MODUM PANELS meet all requirements regardless of housing type or system environments

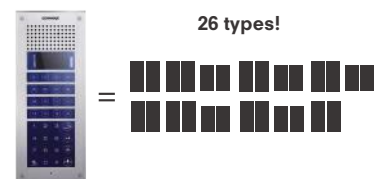



**Access Control (PIN number Access)**

**Access Control (RFID Card Access)**



- 1 Enter the Household Number
- 2 Press Key Button
- 3 Enter the Household PIN Number
- 4 Press Call Button

- 1 Touch the RFID Card
- 2 Open Lobby

**Direct Button Call**

**Household Call**



- 1 Press the Direct Button Number
- 2 Press Call Button
- 1 Press the Household Number
- 2 Press Call Button

**Guard Call**

**Name Search**



- 1 Press the Security Button
- 2 Press the Call Button
- 1 Press Searching Button
- 2 Searching the Name by Pressing the Shift Key Button (pressing the page flip button)
- 3 Press the Call Button

# MODUM DISTRIBUTOR

No limitation on the wiring such as UTP / 2 WIRES / 4 WIRES  
 Connecting modularized distributors with CCTV cameras and FINE VIEW monitors  
 Providing various options in audio and video systems.



Floor Distributor  
CMD-404FU



Floor Distributor  
CMD-404F2



Floor Distributor  
CMD-204F2



Fine view Distributor  
CMD-404CFU



Building Distributor  
CMD-101BU



Building Distributor  
CMD-101B2



Floor Distributor  
CMD-204AF2



Floor Distributor  
CCU-204AGF



CCTV Distributor  
CMD-104VU

### CCTV Camera Connection

Connectable up to 8 channel CCTVs through the CCTV DISTRIBUTOR (4 channels per CCTV DISTRIBUTOR).

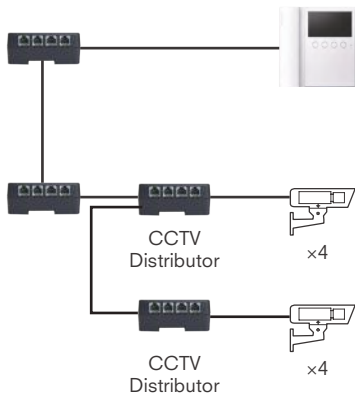

### Combined Audio & Video

Both Audio & Video phones can be installed in a same building.

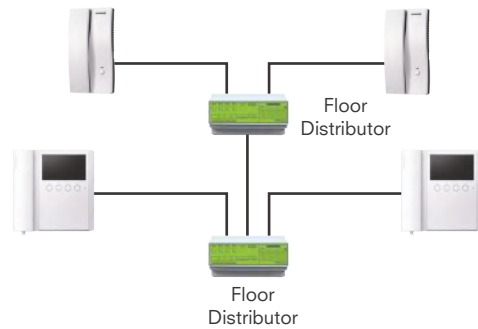

### UTP / 2 WIRES / 4 WIRES

Enabling to integrate using MODUM DISTRIBUTORS in different wiring methods such as UTP / 2 WIRES / 4 WIRES without limitation.

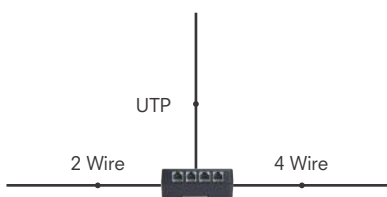

### Connectable with FINE VIEW

FINE VIEW DISTRIBUTOR connects COMMAX FINE VIEW products with 26 different MODUM PANELS (visitor monitoring only).

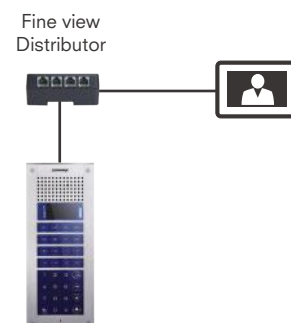

**Household**  
Max. 316 monitors connectable

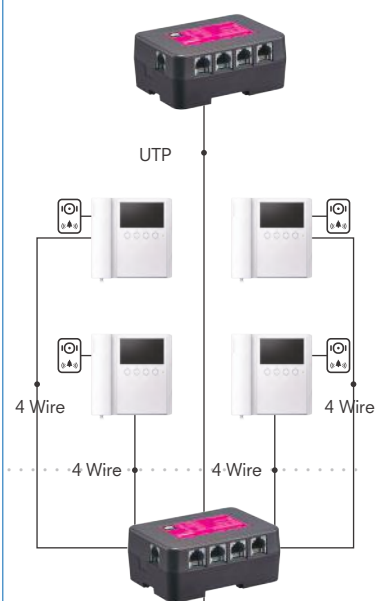
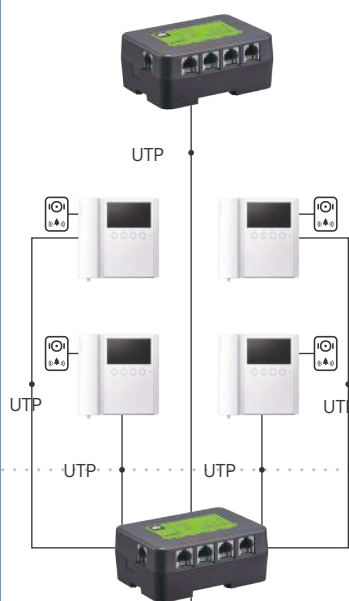
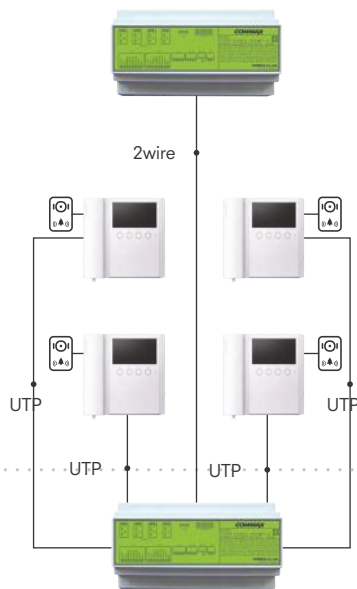

**Floor Distributor**  
Max. 79 floor distributor connectable

2wire

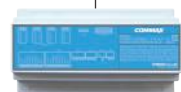

**Building Distributor**

UTP

UTP



UTP

**Public Entrance**  
Up to 99 MODUM PANELS (including outside panel)

UTP



UTP



UTP

UTP

UTP



**Common Area**  
Distance from lobby panel to last monitor : 300 m

UTP

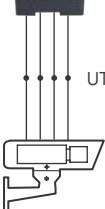

UTP

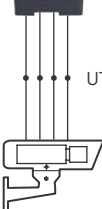

UTP

All UTP

**Floor Distributor  
 CMD-404FU**

Power source	DC 24V, 1A (From Building distributor)
Port	4 ports (Connectable with Video Phone up to 4 ea)
Wiring	-Household unit-to-Floor distributor: UTP -Building distributor-to-Floor distributor: UTP -Floor distributor-to-Floor distributor: UTP
Mount type	Din-Rail Mounted type
Dimension (mm)	106(w)x76(h)x44(d)

F/D

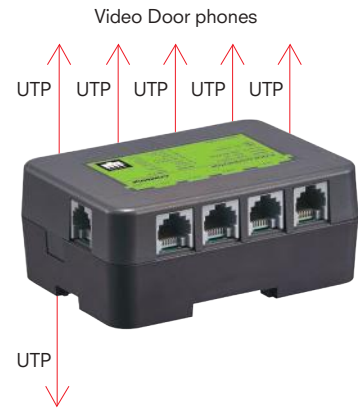

**Building Distributor  
 CMD-101BU**

Power source	DC 24V, 1A (Power supply to floor distributor)
Port	4 ports (Connectable with Panel , Guard, Porter, CCTV distributor)
Wiring	-Building distributor to Modum panel: UTP -Building distributor-to-Floor distributor: UTP -Building distributor-to-CCTV distributor: UTP -Building distributor-to-Guard station: UTP -Building distributor-to-Porter station: UTP
Mount type	Din-Rail Mounted type
Dimension (mm)	106(w)x76(h)x44(d)

B/D



2 Wire + UTP Combination

**Floor Distributor  
 CMD-404F2**

Power source	DC 40V (From Building distributor)
Port	4 ports (Connectable with Video Phone up to 4 ea)
Wiring	-Household unit-to-Floor distributor: UTP -Building distributor-to-Floor distributor: 2 wires -Floor distributor-to-Floor distributor: 2 wires
Mount type	Din-Rail Mounted type
Dimension (mm)	157(w)x86(h)x59(d)

F/D

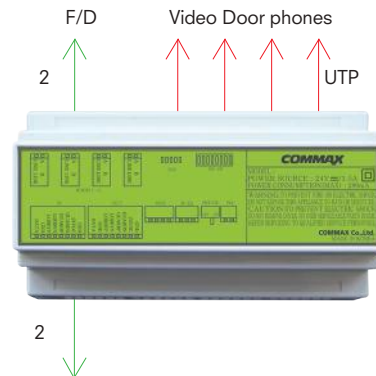

**Building Distributor  
 CMD-101B2**

Power source	DC 40V, 10A (Power supply to floor distributor)
Port	4 ports (Connectable with Panel, Guard, Porter, CCTV distributor)
Wiring	-Building distributor to Modum panel: UTP -Building distributor-to-Floor distributor: 2 wires -Building distributor-to-CCTV distributor: UTP -Building distributor-to-Guard station: UTP -Building distributor-to-Porter station: UTP
Mount type	Din-Rail Mounted type
Dimension (mm)	157(w)x86(h)x59(d)

B/D

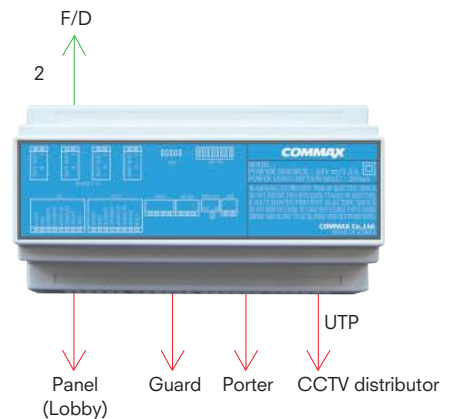

## All 2 Wire Video

### Floor Distributor CMD-204F2

Power source	DC 40V (From Building distributor)
Port	4 ports (Connectable with Video Phone up to 4 ea)
wiring	-Household unit-to-Floor distributor: 2 wires -Building distributor-to-Floor distributor: 2 wires -Floor distributor-to-Floor distributor: 2 wires
Mount type	Din-Rail Mounted type
Dimension (mm)	157(w)x86(h)x59(d)

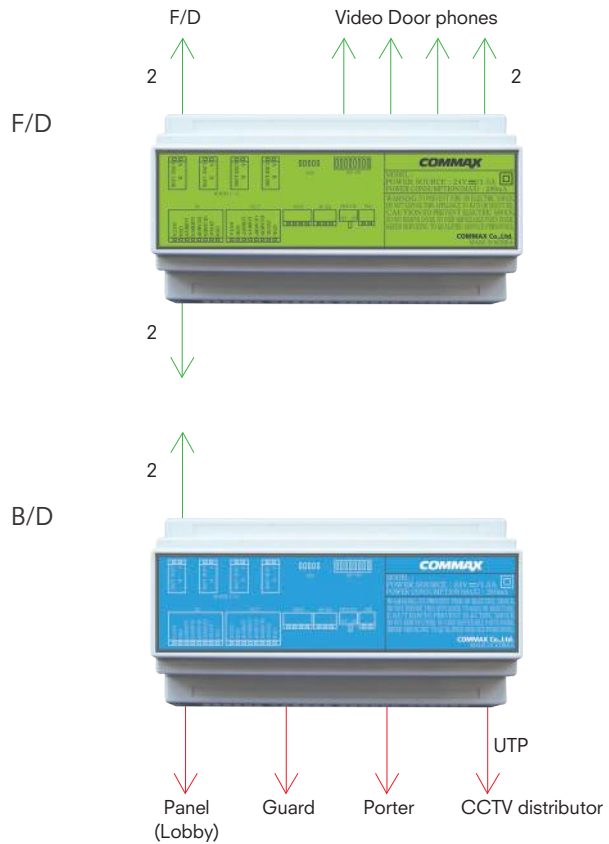

### Building Distributor CMD-101B2

Power source	DC 40V, 10A (Power supply to floor distributor)
Port	4 ports (Connectable with Panel , Guard, Porter, CCTV distributor)
Wiring	-Building distributor to Modum panel: UTP -Building distributor-to-Floor distributor: 2 wires -Building distributor-to-CCTV distributor: UTP -Building distributor-to-Guard station: UTP -Building distributor-to-Porter station: UTP
Mount type	Din-Rail Mounted type
Dimension (mm)	157(w)x86(h)x59(d)

## All 2 Wire Audio

### Floor Distributor CMD-204AF2

Power source	DC 40V (From Building distributor)
Port	4 ports (Connectable with 2 wire Audio phone up to 4 ea)
Wiring	-Household unit-to-Floor distributor: 2 wires -Building distributor-to-Floor distributor: 2 wires -Floor distributor-to-Floor distributor: 2 wires
Mount type	Din-Rail Mounted type
Dimension (mm)	157(w)x86(h)x59(d)

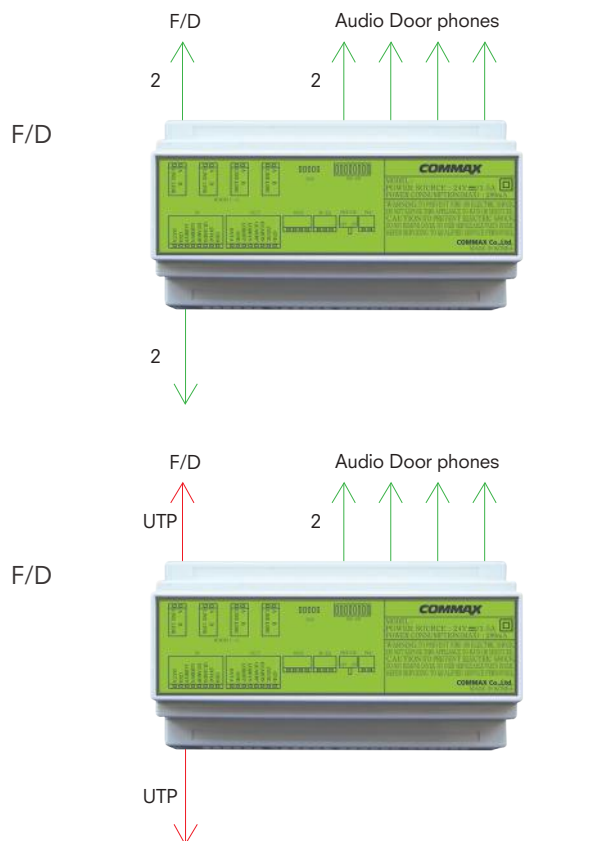

## 2 Wire Audio

### Floor Distributor CCU-204AGF

Power source	DC 24V / 3A
Port	4 ports (Connectable with 2 wire Audio phone up to 4 ea)
Wiring	-Modum panel-to -Floor distributor: UTP -Household unit-to-Floor distributor: 2 wires -Floor distributor-to-Floor distributor: UTP
Mount type	Din-Rail Mounted type
Dimension (mm)	157(w)x86(h)x59(d)



## CCTV Distributor

### CMD-104VU

Power source	DC 12V, 4A PoD(Power on Distributor)
Port	4 ports (Connectable with CCTV camera up to 4 ea)
Wiring	-CCTV distributor-to-Building distributor: UTP -CCTV distributor-to-CCTV cameras: UTP
Mount type	Din-Rail Mounted type
Dimension (mm)	106(w)x76(h)x44(d)

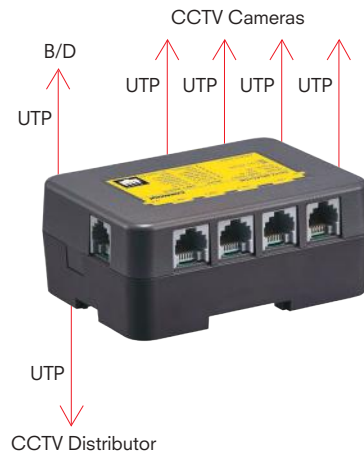

## Connectable Products



CAU-D047TP  
(BULLET)



CAD-I4V7TP  
(DOME)

## Fine View Distributor (Visitor Monitoring Only)

### CMD-404CFU

Power source	DC 24V, 1A
Port	4 ports (Connectable with Fine View Video phone up to 4 ea)
Wiring	-Household unit-to-Floor distributor: UTP -Building distributor-to-Floor distributor: UTP -Floor distributor-to-Floor distributor: UTP
Mount type	Din-Rail Mounted type
Dimension (mm)	106(w)x76(h)x44(d)

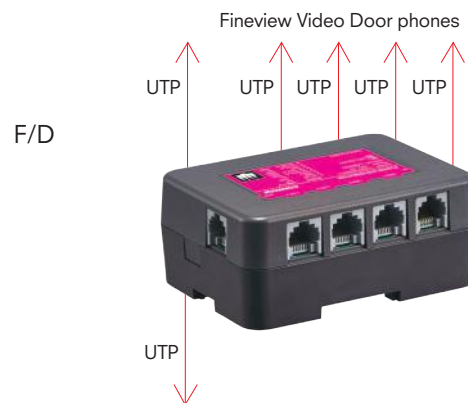

## Fine View Distributor Connectable Products



CDV-70UM  
/ CDV-70U

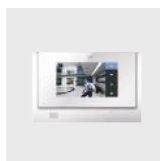

CDV-72UM



CDV-70KM  
/ CDV-70K

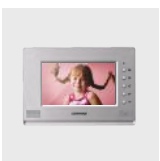

CDV-71AM  
/ CDV-70A



CDV-70P



CDV-43N

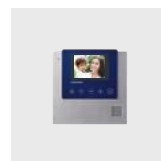

CDV-35U



CDV-35A

CCTV Camera (Bullet) PoD (Power on Distributor)

**CAU-D047TP**

Power	Power from CCTV distributor
Image sensor	1/3" SONY 960H SUPER HAD II CCD
Minimum Illumination	0.1Lux at F1.2
Resolution	700TV Line high resolution
Lens	3.6mm fixed focus lens
Wiring	CCTV distributor-to-CCTV cameras: UTP
DNR	2D/3D DNR



Guard Station

**CDS-2AG**

Power source	DC 12V, 1A
Features	<ul style="list-style-type: none"> <li>• Setting a Floor Distributor -changing a Bldg No./ Household No./PIN number</li> <li>• Paging and calling household</li> <li>• Calling for lobby</li> <li>• Interlocking with unmanned courier system</li> <li>• System setting program</li> </ul>
Mount type	Desk type
Wiring	Building distributor-to-Guard Station: UTP
Distance	Max. 100m
Dimensions (mm)	230(w)x200(h)x35(d)



CCTV Camera (Dome) PoD (Power on Distributor)

**CAD-I4V7TP**

Power	Power from CCTV distributor
Image sensor	1/3" SONY 960H SUPER HAD II CCD
Minimum Illumination	0.1Lux at F1.2
Resolution	700TV Line high resolution
Lens	2.8mm~12mm varifocal lens
Wiring	CCTV distributor-to-CCTV cameras: UTP
DNR	2D/3D DNR



**CDS-70MV (SECUMAX Connectable)**

Power source	DC 14V/2.1A
Features	<ul style="list-style-type: none"> <li>• Setting a Floor Distributor -changing a Bldg No./ Household No./PIN number</li> <li>• Paging and calling household</li> <li>• Calling for lobby</li> <li>• Interlocking with unmanned courier system</li> <li>• System setting program</li> </ul>
LCD size	7 inch Full touch wide color LED
Mount type	Desktop / Surface-mounted type
Wiring	Building distributor-to-Guard Station: UTP
Dimensions (mm)	361(w)x238(h)x22(65)(d)



Porter Phone

**AP-3SG (Porter)**

Power source	AC 100V, 110V, 220V, 50/60Hz
Mount type	Surface-mounted type
Wiring	Building distributor-to-Porter Phone: UTP
Dimensions (mm)	94(w)x185(h)x38(d)



Single House

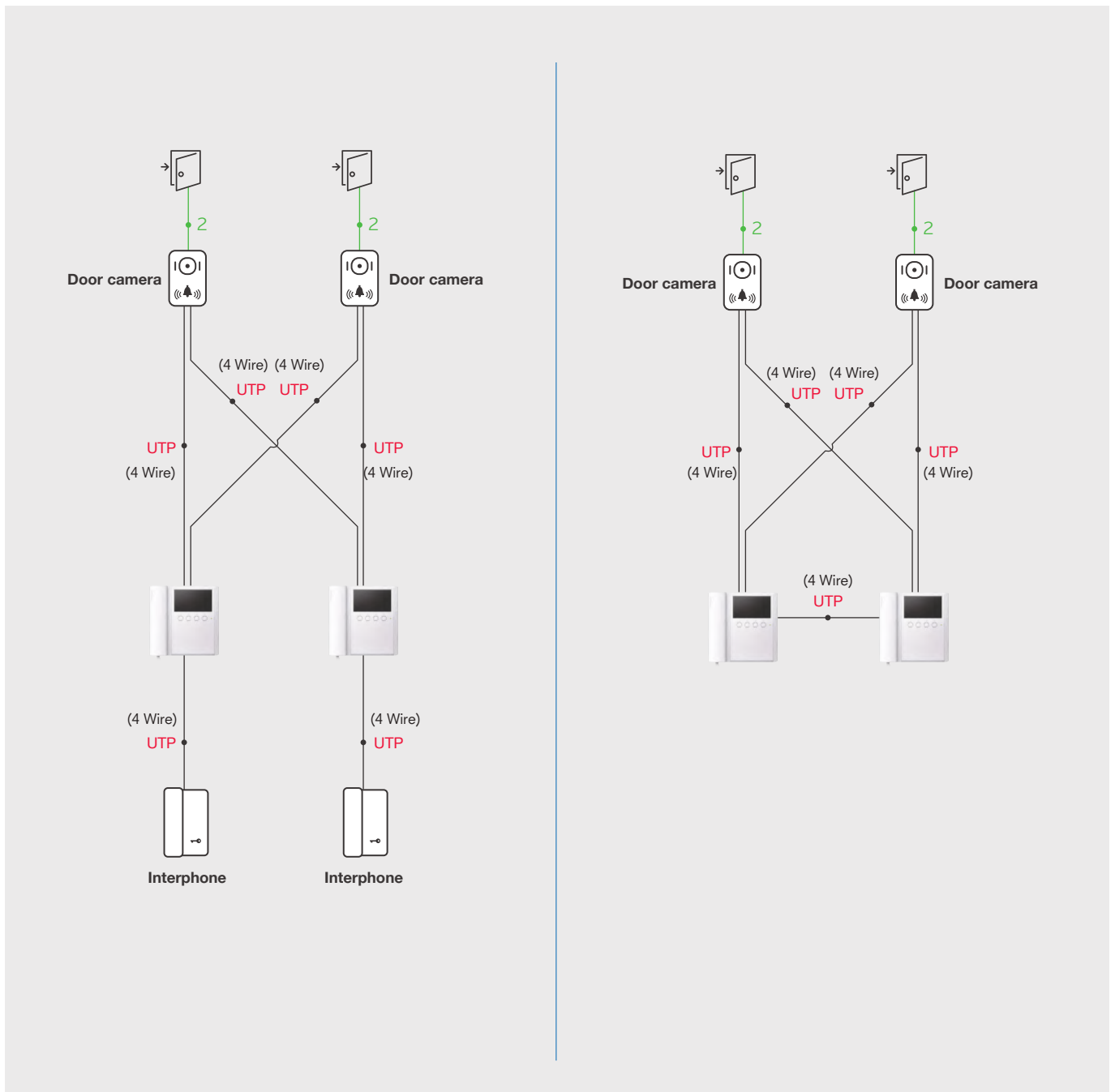

**Single House (A type)**

- Easy installation for a 2 doors house (Front & garage door)
- Support 2 monitors, 2 cameras and 2 interphones

**Single House (B type)**

- Easy installation for a 2 doors house (Front & garage door)
- Support 2 monitors, 2 cameras
- Intercommunication between 2 monitors

## Small Apartment(UTP)

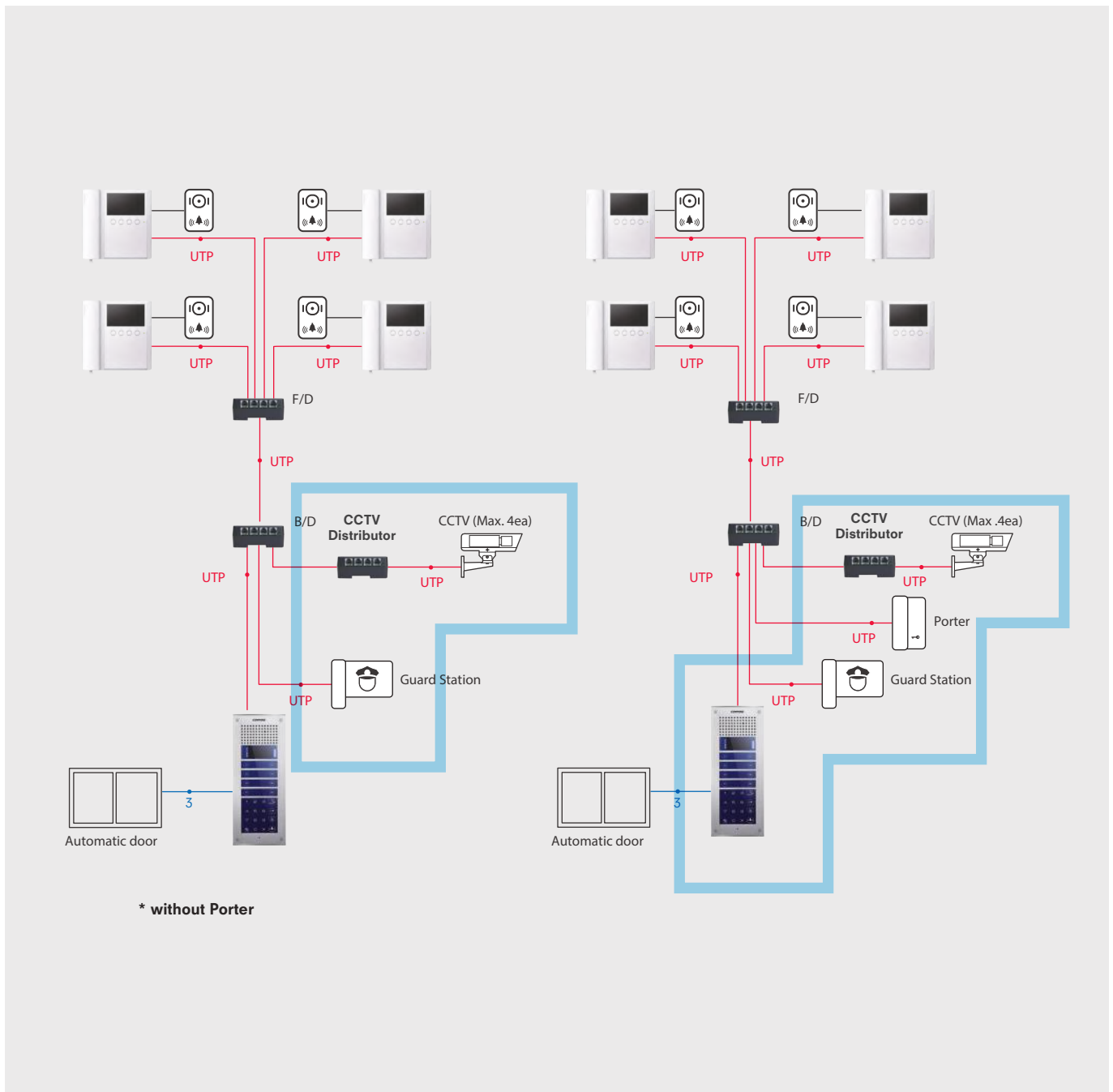

**The best unmanned security system for a small apartment. Supporting up to 316 households and simple door opening with various access ways.**

- PIN number
- RFID card
- Direct button call
- Name search
- Guard call
- Porter call

## Small Apartment (2 Wire)

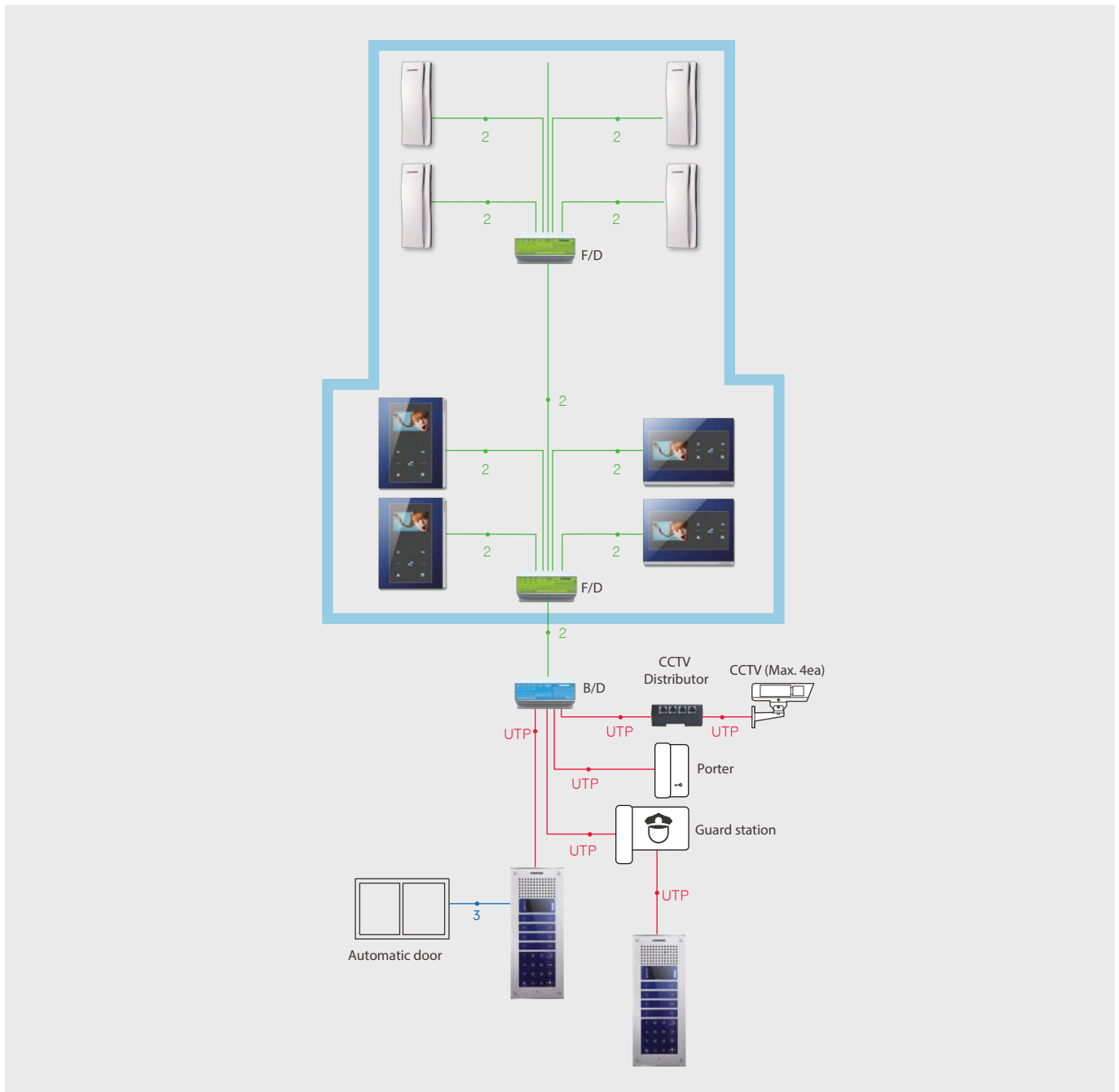

### 2 Wire Video & Audio

- 2 Wire solution for Video and Audio units in a same building
- Apply both systems not only for existed buildings but for new buildings



## Apartment Complex

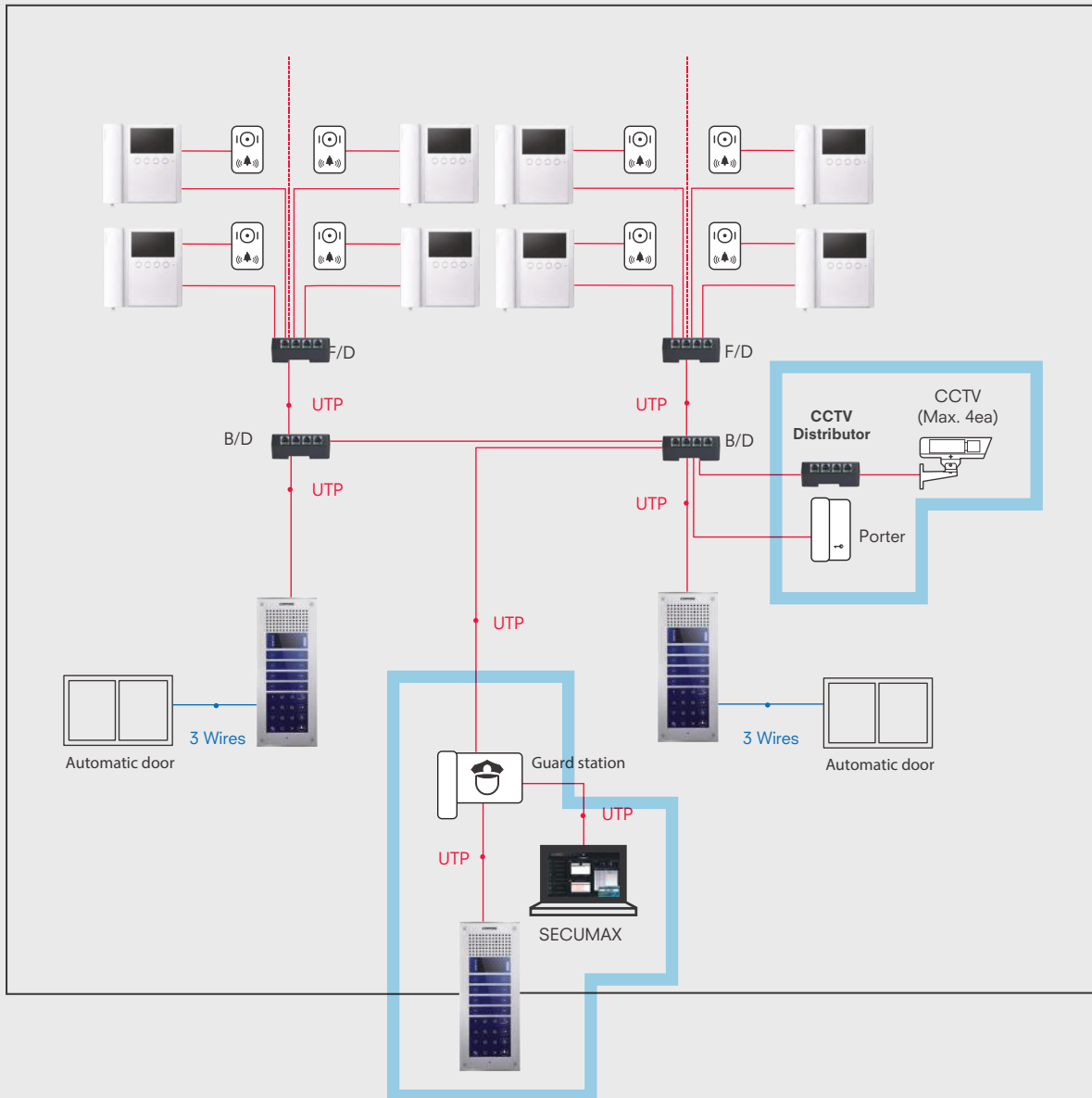

- Interfacing with CCTV, Guard and Porter
- A single integrated control system applying to an apartment complex
- Providing a various configurations for the safety with SECUMAX program

# MODUM VIDEO PHONE, VIDEO & AUDIO PANEL

## Premium Video Phone

### CMV-70S



- CCTV Monitoring & Quad display (only for connecting with MODUM DVR)
  - Connectable with 180° Door camera
  - Connectable with security sensor
  - Guard Call/Porter Call
  - Memory storing in Micro SD memory
  - Video talk and door lock release enable
  - Single House/Apartment Complex convertible
  - Expandable up to 2 monitors, 2 door cameras and 2 Interphones
- |                 |  |
|-----------------|--|
| Power source    | DC from distributor or AC 110-240V, 50/60Hz                      |
| Display         | 7" inch Full touch wide color LED                                |
| Mount type      | Surface-mounted type   |
| Wiring          | Door camera: UTP or 2 Wires<br>Floor Distributor: UTP or 2 Wires |
| Operating temp. | 0°C~+60°C  |
| Dimension (mm)  | 243(w)x174(h)x33(d)  |

## Standard Video Phone

### CMV-43SV / CMV-43S

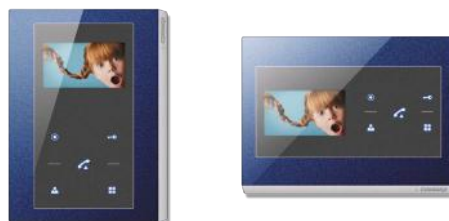

- CCTV Monitoring
  - Guard Call
  - Porter Call
  - Video talk and door lock release enable
  - Compatible with Single House and Apartment Complex
  - Expandable up to 2 monitors, 2 door cameras and 2 Interphones
- |                 |  |
|-----------------|--|
| Power source    | DC from distributor or AC 110-240V, 50/60Hz                      |
| Display         | 4.3 inch wide color LED  |
| Mount type      | Surface-mounted type   |
| Wiring          | Door camera: UTP or 2 Wires<br>Floor Distributor: UTP or 2 Wires |
| Operating temp. | 0°C~+60°C  |
| Dimension (mm)  | 174(w)x243(h)x33(d)<br>243(w)x174(h)x33(d)                       |

## Basic Video Phone

### CMV-43A



- 4.3 inch LED display
  - CCTV monitoring
  - 2 Door Opening
  - Guard Call / Porter Call
- |                 |   |
|-----------------|---|
| Power source    | AC 110-240V, 50/60Hz  |
| LCD size        | 4.3 inch wide color LED   |
| Mount type      | Surface-mounted type  |
| Wiring          | Floor distributor: UTP<br>Door camera: UTP<br>Door camera: 28m (0.65Ø)<br>Interphone: 20m |
| Distance        |   |
| Operating temp. | 0°C~40°C  |
| Dimension (mm)  | 230(w)x209(h)x27(d)   |

## Crystal MODUM Panel

### DRC-703LC/RF1



- 3.5 inch LED display
  - Page and call a household unit or a security guard station
  - Various verification methods (PIN number and RFID card)
  - Expandable up to 99 units of DRC-703 LC/RF1
  - Mirror view of a visitor enabled when paging
- |                |                               |
|----------------|-------------------------------|
| Power source   | DC 12V/1A                     |
| Power          | Standby: 200mA                |
| Consumption    | Maximum: 450mA                |
| Wiring         | UTP(Cat. 5e)                  |
| Angle of View  | Horizontal: 68° Vertical: 55° |
| RFID card      | 13.56Mhz (Optional)           |
| Dimension (mm) | 244(w)x270(h)x17(43)(d)       |

## Door Camera



DRC-4U (BLUE/WHITE)

DRC-41UN

DRC-40KH/40K

DRC-4G

DRC-4FC

DRC-4CGN2

DRC-4CPN2

**CMP-2BCT**  
**CMP-2BCT/RF1**  
**CMP-4BCT**  
**CMP-4BCT/RF1**



**CMP-2BC**  
**CMP-4BC**



- Access Control (PIN number/RFID card)
  - 8 button Direct button call (CMP-2BCT)
  - 16 button Direct button call (CMP-4BCT)
  - Page and call a household unit or a security guard station
  - Name searching through 2.4" OLED display
- |                 |                          |
|-----------------|--------------------------|
| Power source    | DC 12V, 1A               |
| Mount type      | Built-in (Flush mounted) |
| RFID card       | 13.56Mhz (optional)      |
| Display         | 2.4" OLED display        |
| Image sensor    | C-MOS (Pin-hole type)    |
| Angle of view   | Horiz.: 47° Vert.: 35°   |
| Lighting        | Built-in White LED       |
| Operating temp. | -40°C~+60°C              |
| Dimension (mm)  | 130(w)x315(h)x12(38)(d)  |

- 16 Direct buttons call (CMP-2BC)
  - 32 Direct buttons call (CMP-4BC)
  - Page and call a household unit
- |                 |                          |
|-----------------|--------------------------|
| Power source    | DC 12V, 1A               |
| Mount type      | Built-in (Flush mounted) |
| Image sensor    | C-MOS (Pin-hole type)    |
| Angle of view   | Horiz.: 47° Vert.: 35°   |
| Operating temp. | -40°C~+60°C              |
| Dimension (mm)  | 130(w)x315(h)x12(38)(d)  |

**CMP-2BX**  
**CMP-4BX (EXTENSION PANEL)**

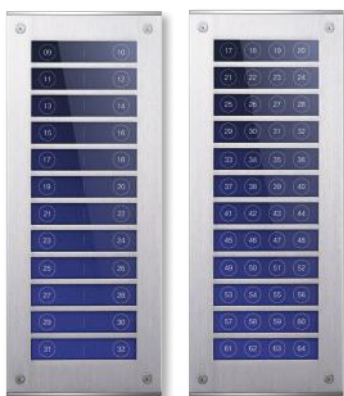

**DRC-GUM**  
**DRC-12UX (EXTENSION PANEL)**



- 24 Direct buttons call Extension panel (CMP-2BX)
  - 48 Direct buttons call Extension panel (CMP-4BX)
- |                 |                          |
|-----------------|--------------------------|
| Power source    | From main panel          |
| Mount type      | Built-in (Flush mounted) |
| Operating temp. | -40°C~+60°C              |
| Dimension (mm)  | 130(w)x315(h)x12(38)(d)  |

- Access Control (PIN number/RFID card)
  - Page and call a household unit or a security guard station
  - Name searching function
  - 12 Direct buttons call Extension panel with name plate
- |                 |                          |
|-----------------|--------------------------|
| Power source    | DC 12V, 1A               |
| Mount type      | Built-in (Flush mounted) |
| RFID card       | 13.56Mhz (optional)      |
| Image sensor    | Color C-MOS 1/4inch      |
| Lighting        | White LED x 2            |
| Wiring          | UTP (Cat. 5e)            |
| Operating temp. | -40°C~+60°C              |
| Dimension (mm)  | 130(w)x315(h)x12(38)(d)  |

**DRC-900LC/RF1**

- Vandal-proof Aluminium Die-casting Case
  - Hidden Pinhole camera
  - IR sensor Type Anti-freezing Buttons
  - Endurability in Extreme Cold -40°C
  - Registering up to 3 RFID cards per each household
  - Security guard station call enabled
  - House call by household number
- |                |                                 |
|----------------|---------------------------------|
| Power source   | DC 12V, 1A                      |
| Mount type     | Flush mounted type              |
| RFID card      | 13.56Mhz (optional RF function) |
| Wiring         | UTP (CAT. 5e)                   |
| Dimension (mm) | 136(w)x260(h)x36(d)             |

**CMP-CTS  
CMP-CTS/RF1**

- Access Control (PIN number/ RFID card)
  - Page and call a household unit or a security guard station
  - Name searching through 2.4" OLED display
- |                 |                          |
|-----------------|--------------------------|
| Power source    | DC 12V, 1A               |
| Mount type      | Built-in (Flush mounted) |
| RFID card       | 13.56Mhz (optional)      |
| Display         | 2.4" OLED display        |
| Image sensor    | C-MOS (Pin-hole type)    |
| Angle of view   | Horiz.: 47° Vert.: 35°   |
| Lighting        | Built-in White LED       |
| Operating temp. | -40°C~+60°C              |
| Dimension (mm)  | 130(w)x249(h)x12(38)(d)  |

**CMP-2BCS  
CMP-4BCS**

- 8 Direct buttons call (CMP-2BCS)
  - 16 Direct buttons call (CMP-4BCS)
  - Page and call a household unit
- |                 |                          |
|-----------------|--------------------------|
| Power source    | DC 12V, 1A               |
| Mount type      | Built-in (Flush mounted) |
| Image sensor    | C-MOS (Pin-hole type)    |
| Angle of view   | Horizon.: 47° Vert.: 35° |
| Operating temp. | -40°C~+60°C              |
| Dimension (mm)  | 130(w)x249(h)x12(38)(d)  |

**CMP-2BXS  
CMP-4BXS (EXTENSION PANEL)**

- 16 Direct buttons call Extension panel (CMP-2BXS)
  - 32 Direct buttons call Extension panel (CMP-4BXS)
- |                 |                          |
|-----------------|--------------------------|
| Power source    | From main panel          |
| Mount type      | Built-in (Flush mounted) |
| Operating temp. | -40°C~+60°C              |
| Dimension (mm)  | 130(w)x249(h)x12(38)(d)  |

# MODUM AUDIO PHONE, AUDIO PANEL

## Audio Phone

### AP-2SAG



- 2 wire connection with non-polarity from a floor distributor
- Talk with a visitor and door release capability

Power source	24V (From floor distributor)
Wiring	2 wires with non-polarity
Distance	100m (0.65Ø)
Operating temp.	0°C~+40°C
Dimension	70(w)x210(h)x60(d)

## MODUM Panels (Audio)

### CMP-2BAT CMP-2BAT/RF1 CMP-4BAT CMP-4BAT/RF1



- Access Control (PIN number/RFID card)
- 8 Direct buttons call (CMP-2BAT)
- 16 Direct buttons call (CMP-4BAT)
- Page and call a household unit or a security guard station
- Name searching through 2.4" OLED display

Power source	DC 12V, 1A
Mount type	Built-in (Flush mounted)
RFID card	13.56Mhz (optional)
Operating temp.	-40°C ~ +60°C
Dimension (mm)	130(w)x315(h)x12(38)(d)

### CMP-2BA CMP-4BA



- 16 Direct buttons call (CMP-2BA)
- 32 Direct buttons call (CMP-4BA)
- Page and call a household unit

Power source	DC 12V, 1A
Mount type	Built-in (Flush mounted)
Operating temp.	-40°C~+60°C
Dimension (mm)	130(w)x315(h)x12(38)(d)

### CMP-2BX CMP-4BX (EXTENSION PANEL)



- 24 Direct buttons call (CMP-2BX Extension panel)
- 48 Direct buttons call (CMP-4BX Extension panel)

Power source	From main panel
Mount type	Built-in (Flush mounted)
Operating temp.	-40°C~+60°C
Dimension (mm)	130(w)x315(h)x12(38)(d)



## CMP-ATS CMP-ATS/RF1



- Access Control (PIN number/RFID card)
  - Page and call a household unit or a security guard station
  - Name searching through 2.4" OLED display
- |                 |                          |
|-----------------|--------------------------|
| Power source    | DC 12V, 1A               |
| Mount type      | Built-in (Flush mounted) |
| RFID card       | 13.56Mhz (optional)      |
| Display         | 2.4" OLED display        |
| Operating temp. | -40°C~+60°C              |
| Dimension (mm)  | 130(w)x249(h)x12(38)(d)  |

## CMP-2BAS CMP-4BAS



- 8 Direct buttons call (CMP-2BAS)
  - 16 Direct buttons call call (CMP-4BAS)
  - Page and call a household unit
- |                 |                          |
|-----------------|--------------------------|
| Power source    | DC 12V, 1A               |
| Mount type      | Built-in (Flush mounted) |
| Operating temp. | -40°C~+60°C              |
| Dimension (mm)  | 130(w)x249(h)x12(38)(d)  |

## CMP-2BXS CMP-4BXS (EXTENSION PANEL)



- 16 Direct buttons call
  - Extension panel (CMP-2BXS)
  - 32 Direct buttons call
  - Extension panel (CMP-4BXS)
- |                 |                          |
|-----------------|--------------------------|
| Power source    | From main panel          |
| Mount type      | Built-in (Flush mounted) |
| Operating temp. | -40°C~+60°C              |
| Dimension (mm)  | 130(w)x249(h)x12(38)(d)  |

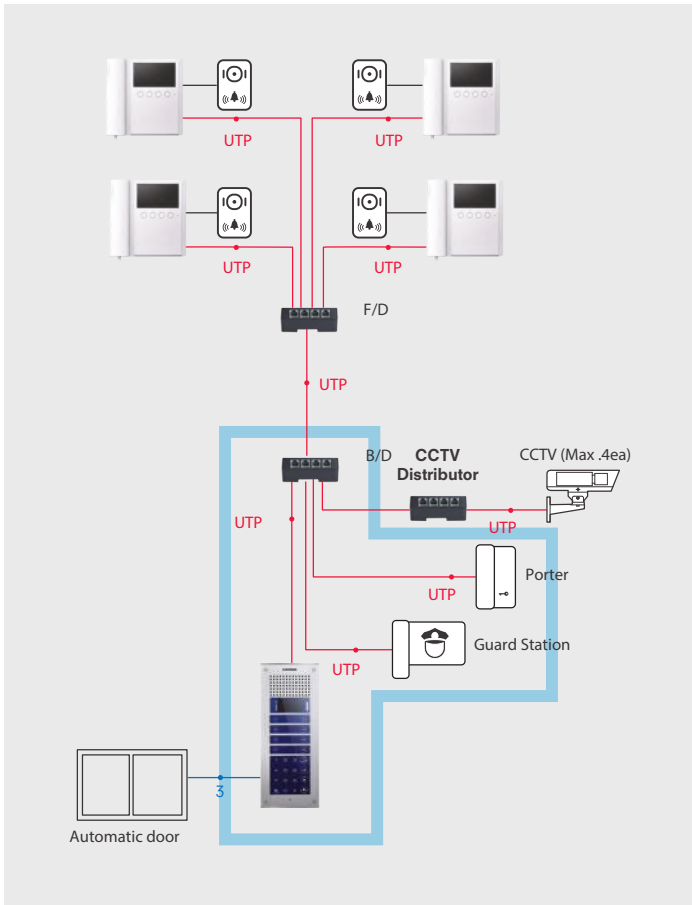

1. Modum Panel Wire Connection

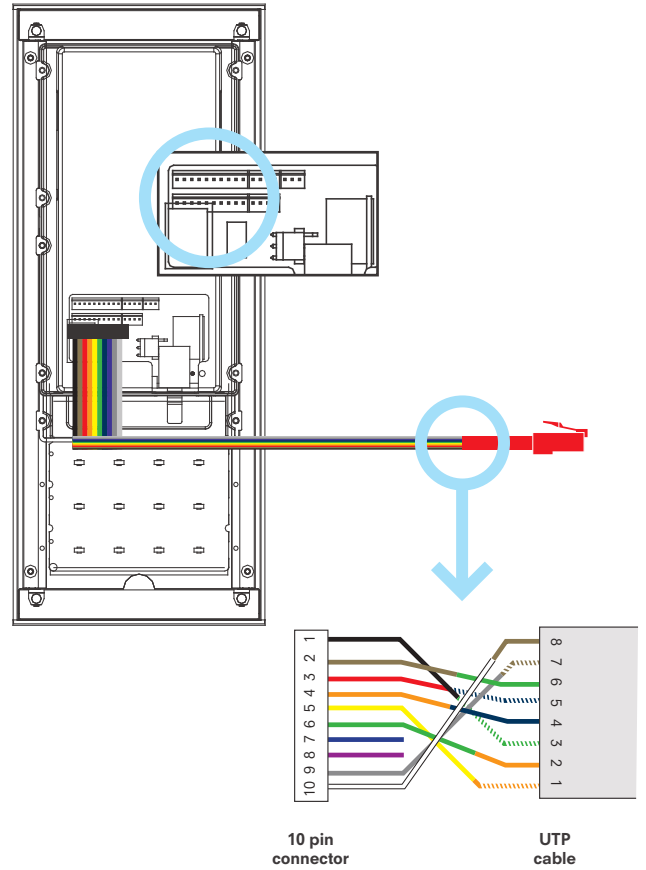

2. Building Distributor Wire Connection

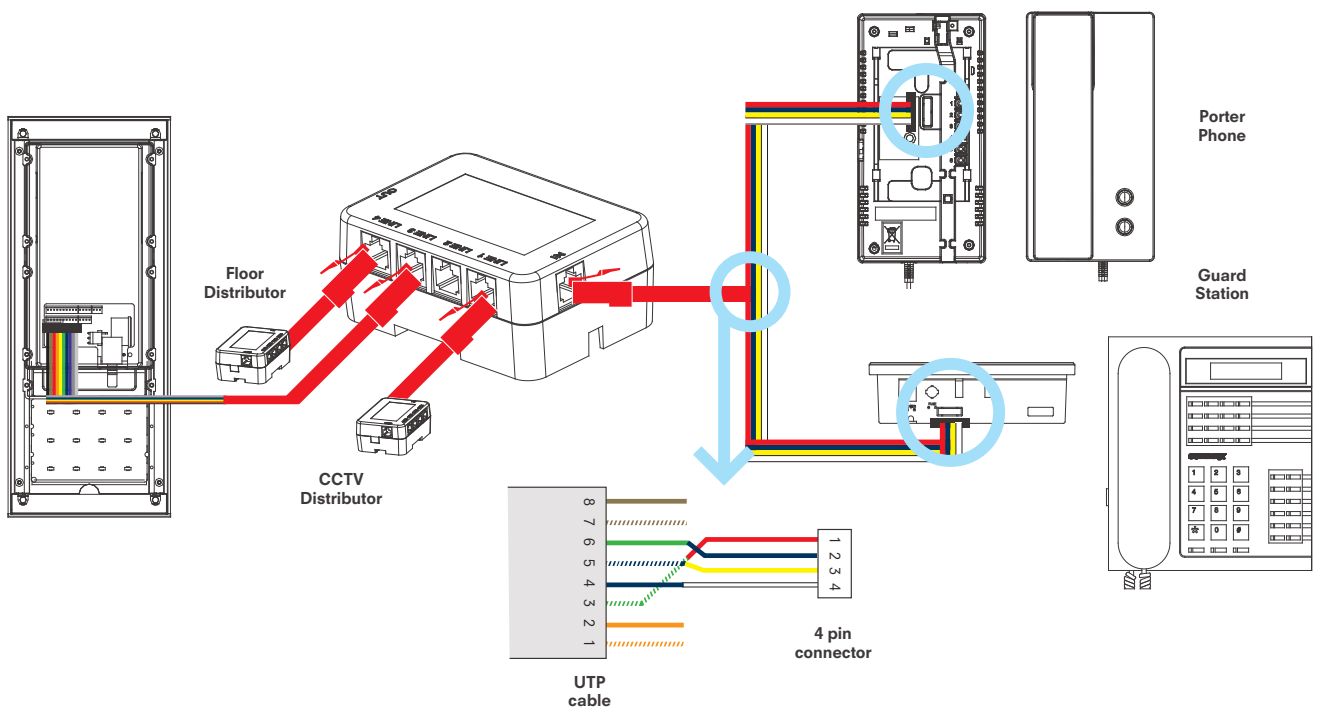

3. Porter & Guard Wire Connection

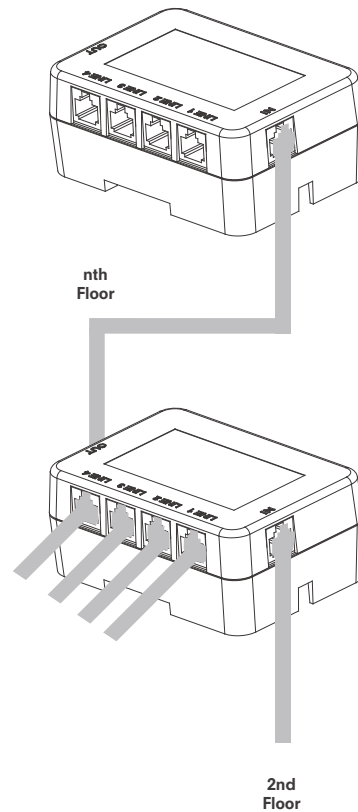
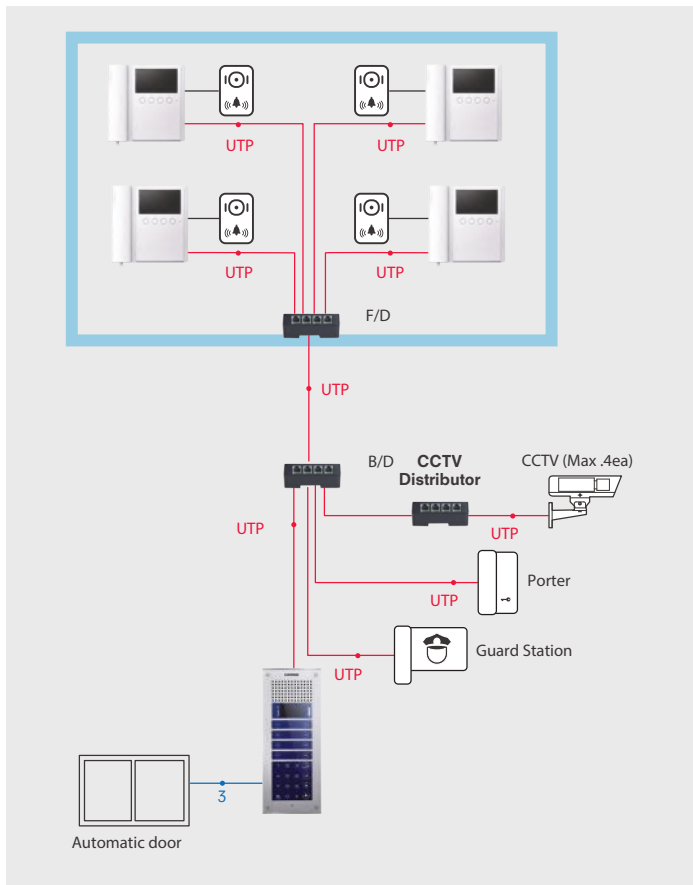

4. Floor Distributor To Floor Distributor Wire Connection

5. Video Phone To Floor Distributor Wire Connection

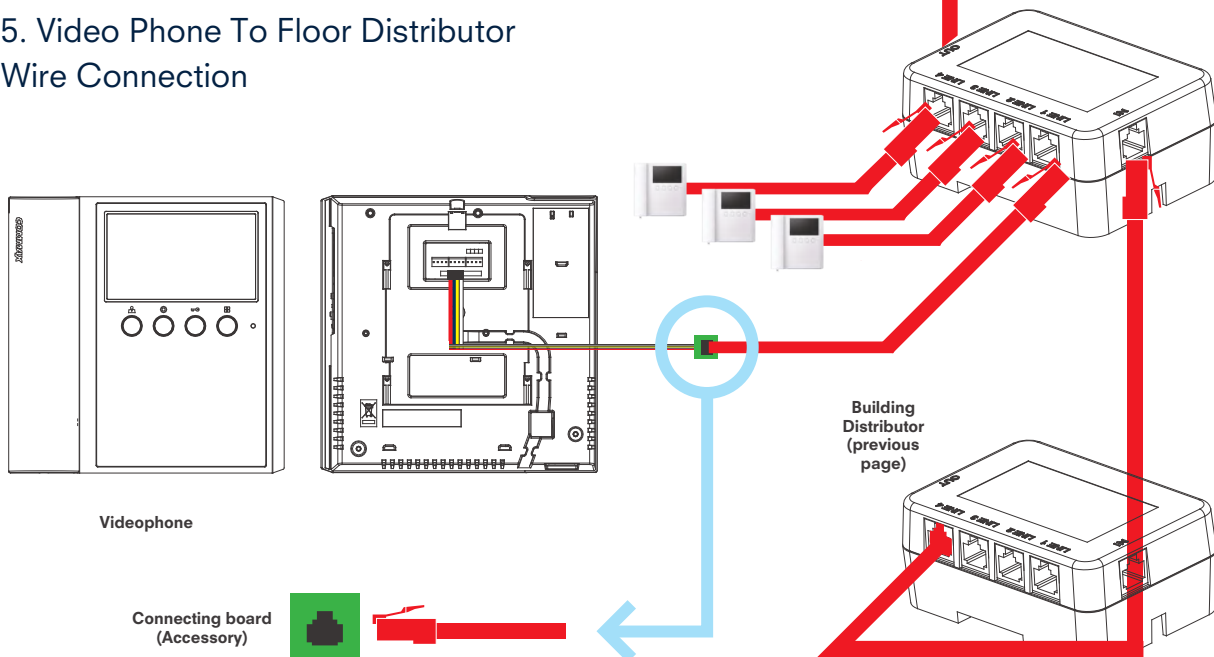

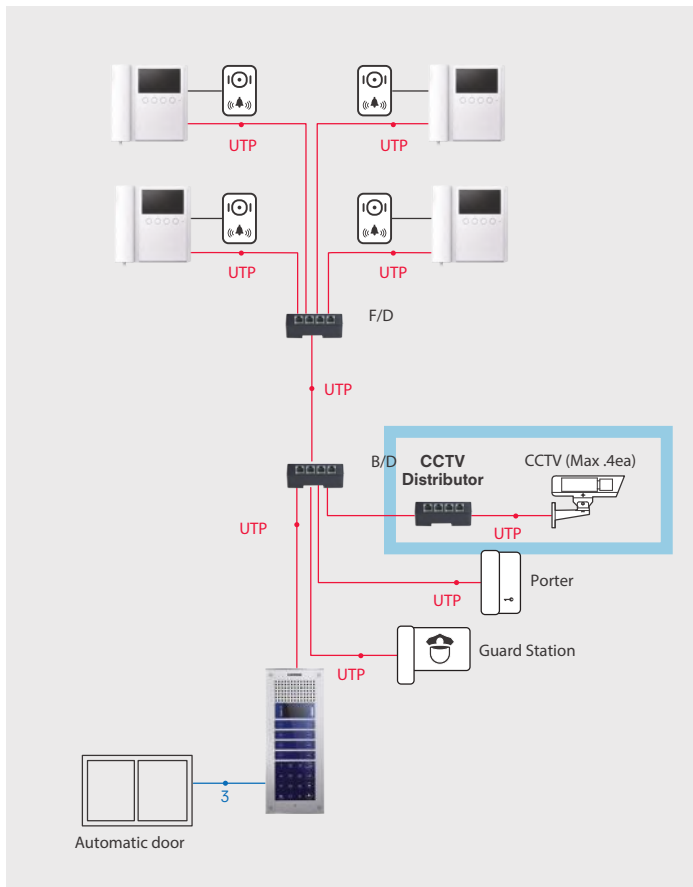

### 6. CCTV Camera To CCTV Distributor Wire Connection

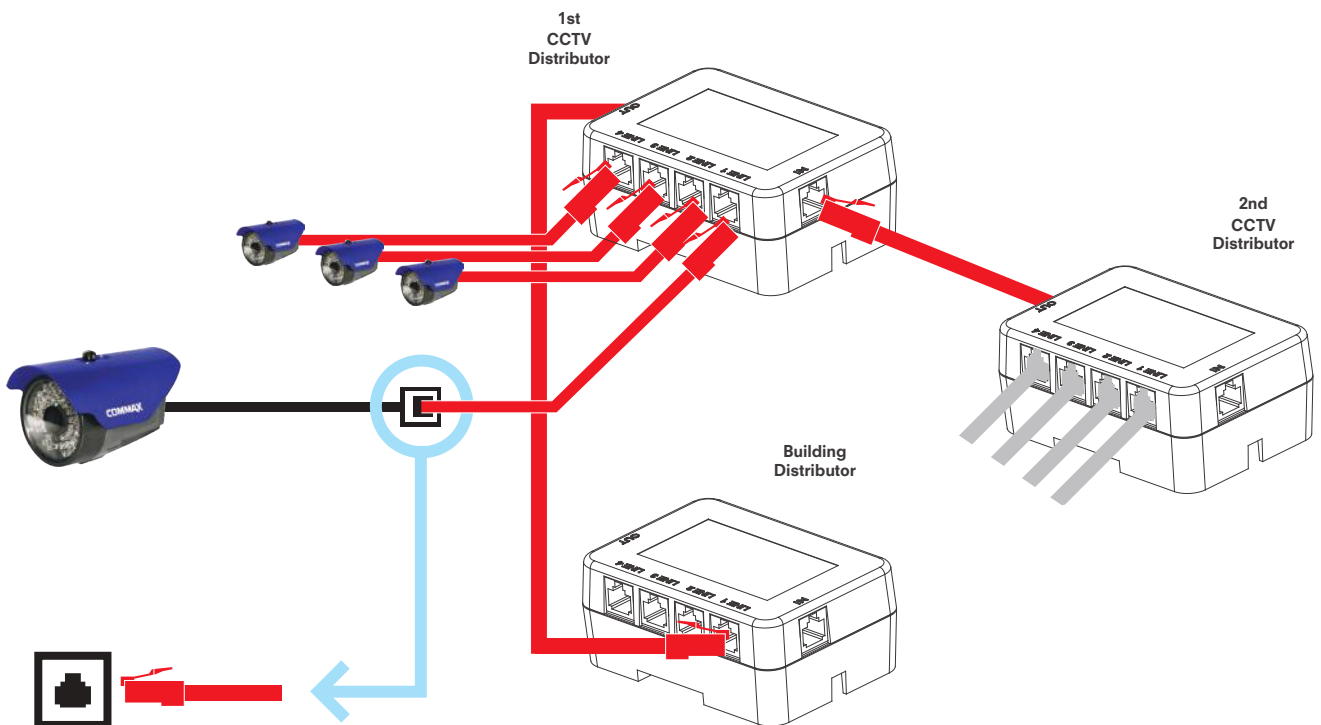

[PIN Number Setting] by MODUM PANEL Program

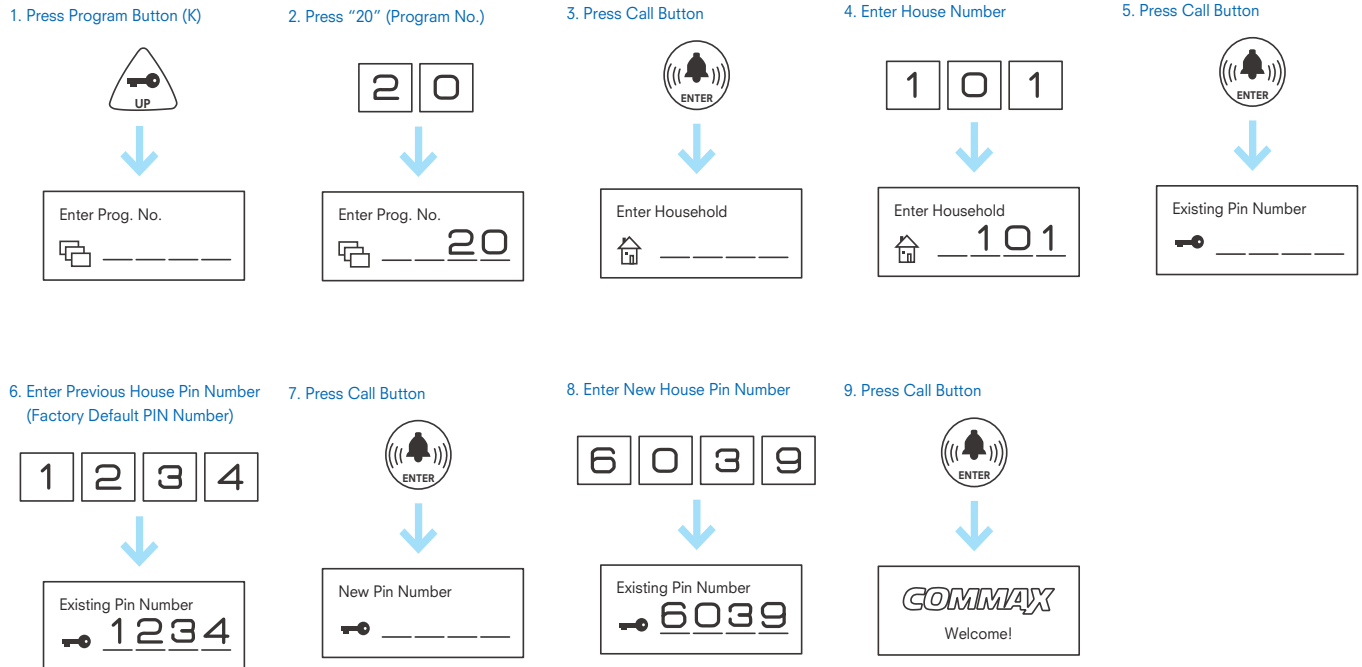

[RF Card Key Setting] by MODUM PANEL Program

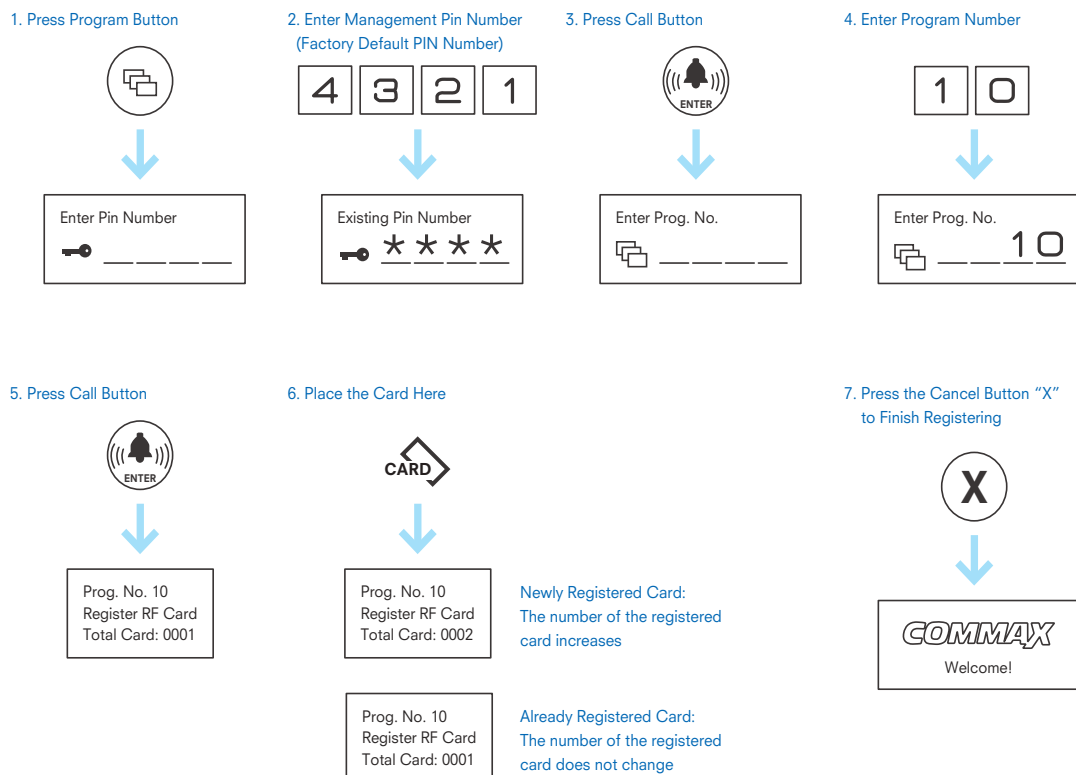



[Building Number Setting] by MODUM PANEL

1. Press Program Button (P)



2. Enter Management Pin Number  
(Factory Default PIN Number)



3. Press Call Button



4. Enter Program Number (2)

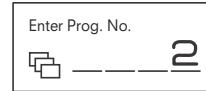

5. Press Call Button Previous  
Building Number is Displayed

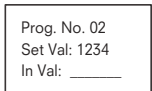

6. Enter Management Pin Number

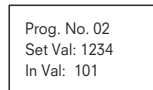

7. Press the Call Button and Building  
Number Registration is Complete



[Household Number AUTO Setting] by Floor Distributor

※ Just DIP Switch setting of each F/D, household numbers are defined automatically

※ No Needed Setting in One Building, (Plug and play for Guard, Porter)

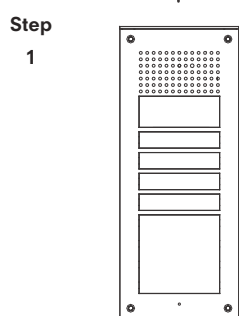
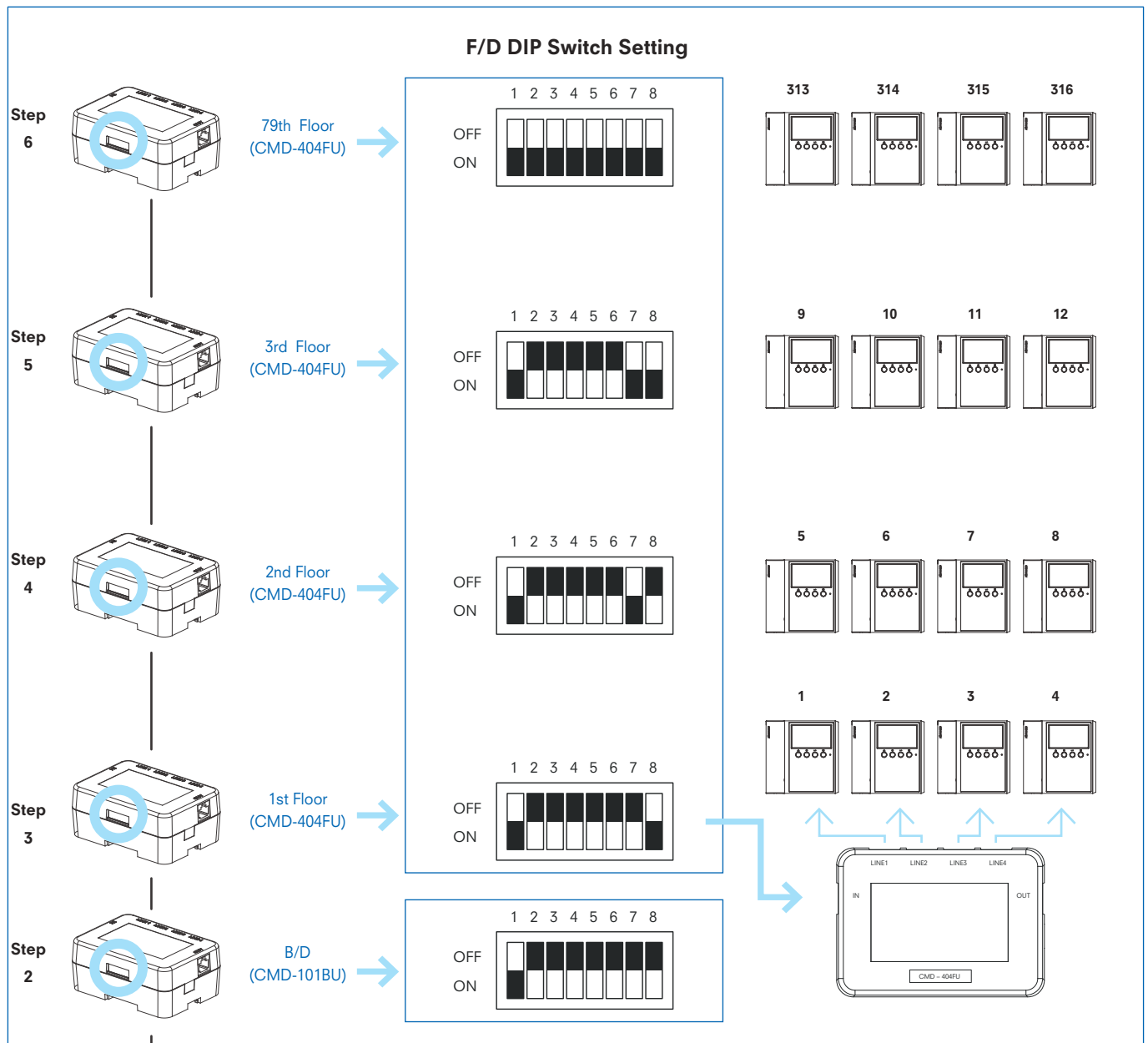

**CMD-404FU References**

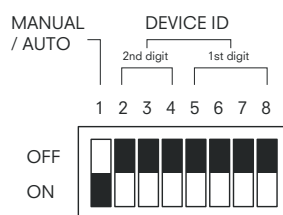

※ No. 1 (Select MANUAL / AUTO): OFF=MANUAL/ON=AUTO  
No. 2 ~ 4 (Select ID: 2nd digit): Consist of BCD code  
No. 5 ~ 8 (Select ID: 1st digit): Consist of BCD code

※ Select 'Auto Mode'  
1. Auto Mode (ON): If No. 1 switch is on while the device is booting, it will be operated with Auto mode. Household number will be allocated automatically in order by previously set ID number of lobby phone.

# SETTING

## [Household Number MANUAL Setting] by Floor Distributor

※ In Manual mode, the installer has to set each household number. But any digit can be used according to the customer's needs like 101,102,103...

※ Plug and play for Guard, Porter

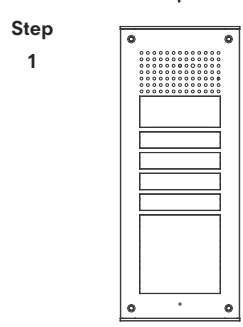
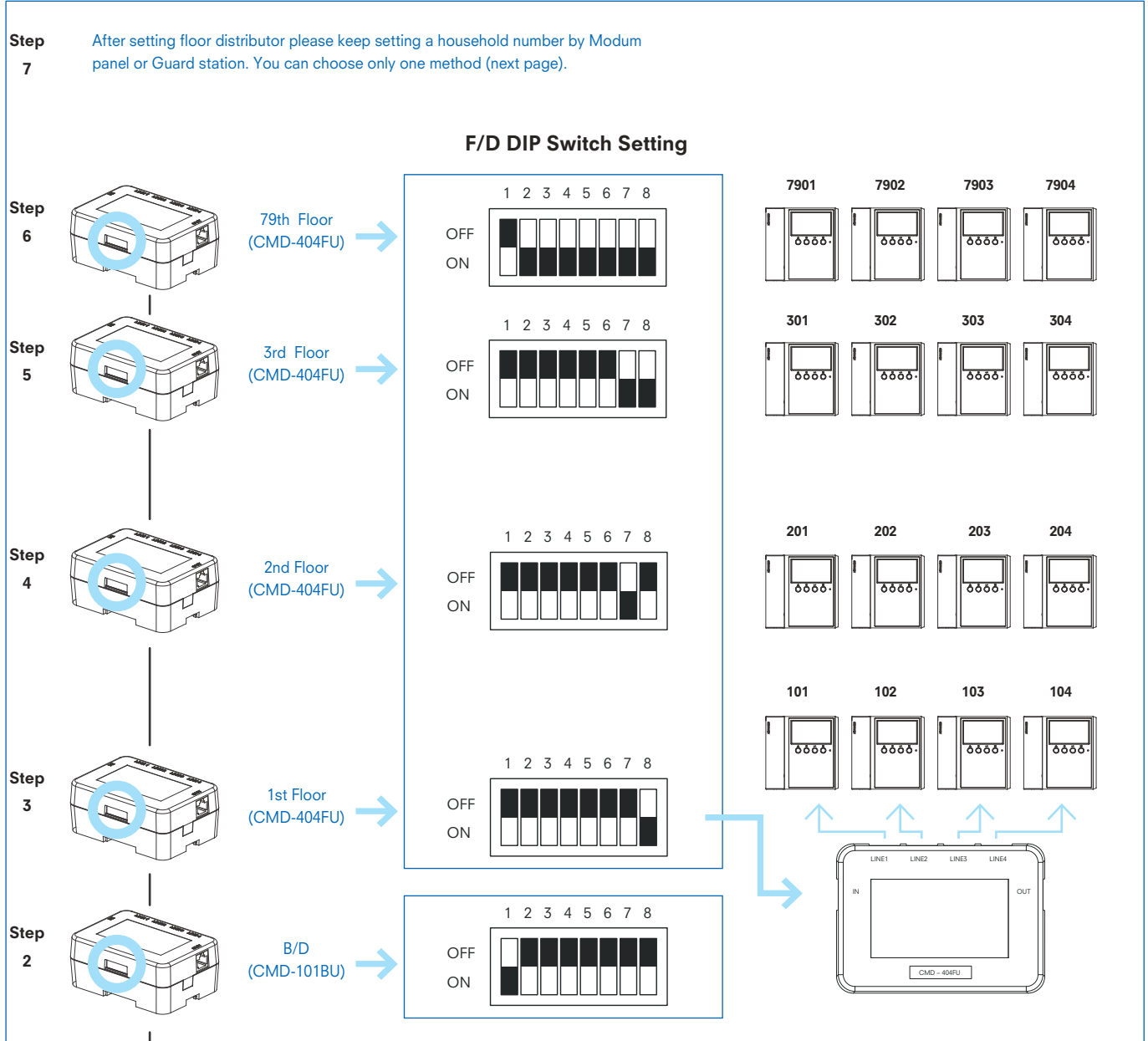

### CMD-404FU References

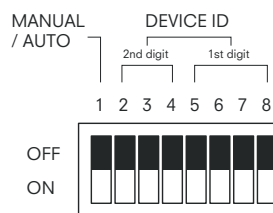

※ No. 1 (Select MANUAL /AUTO): OFF=MANUAL/ON=AUTO  
 No. 2 ~ 4 (Select ID: 2nd digit): Consist of BCD code  
 No. 5 ~ 8 (Select ID: 1st digit): Consist of BCD code

※ Select 'Manual mode'  
 1. Manual Mode (OFF): If No. 1 switch is off while the device is booting, it will be operated with Manual mode. From lobby phone, you can set the Bldg No. or household No. by yourself.

[Household Number MANUAL Setting] by MODUM PANEL

1. Press Program Button



2. Enter Management Pin Number  
(Factory Default PIN Number)

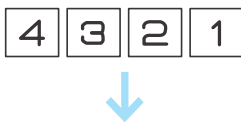

3. Press Call Button

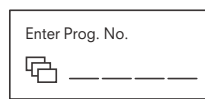

4. Enter Program Number

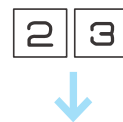

5. Press Call Button

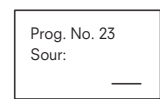

6. Enter Program Number

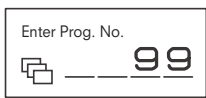
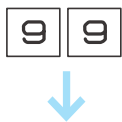

7. Press Call Button

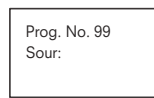

8. Press the Cancel Button "X" to Finish Registering



9. Press Program Button



10. Enter Management Pin Number

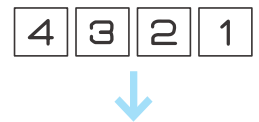

11. Press Call Button



12. Enter Program Number

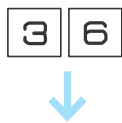

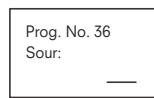

13. Press Call Button

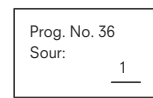

14. Press Call Button



15. Press  Button and 

Searching the information  
Want to change

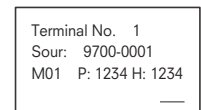

\* Enter Module ID ex) 1

16. Press the Setting Information  
(If you want to set terminal  
Number 1 by 101 (household  
number), 3690 (password) and  
2 (lobby ID)

\*M01 : Lobby ID / P: pin No.  
H: household No.

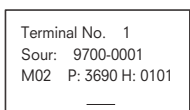

17. Press Program Button



[Household Number MANUAL Setting] by Guard Station

1. Press Program Check Button

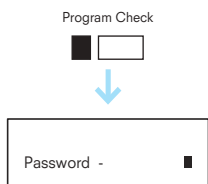

2. Enter the Password "9999"

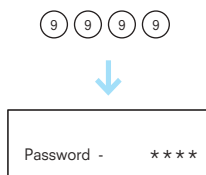

3. Press Program Button

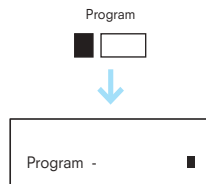

4. Press ▶ Button 6 times

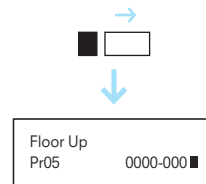

5. Enter Floor Distributor Code

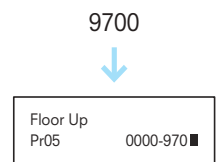

6. Press Program Button

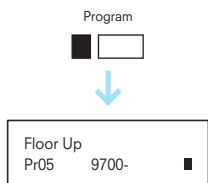

7. Enter Floor Distributor ID

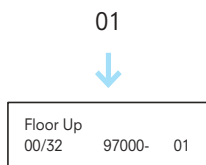

8. Press Program Button

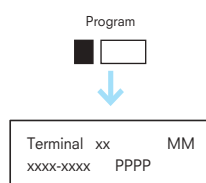

9. Press ▶ Button and Searching the Port

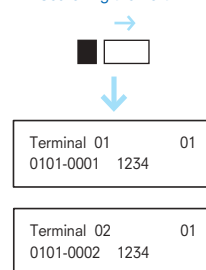

10. Press Program Button

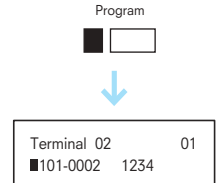

11. Press the Household Information  
(Building No. / Household No. /  
Pin Number)

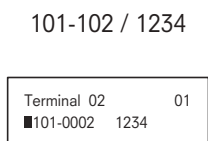

12. Press Remote Control Button

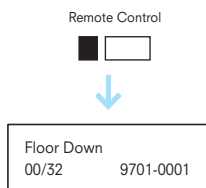

# SECUMAX

COMMAX SECUMAX Program is the software that can control integrating apartment complex. Guarantee the security by integrating controls of various functions such as access information, visitor checking/registering and parking record.

## Register Information



Register, inquire and delete resident's RF-Card, resident's car (Option), fingerprints (Option). Possible to save those who entered, entrance method and entrance time and to inquire and print the information.

## Alarm Functions

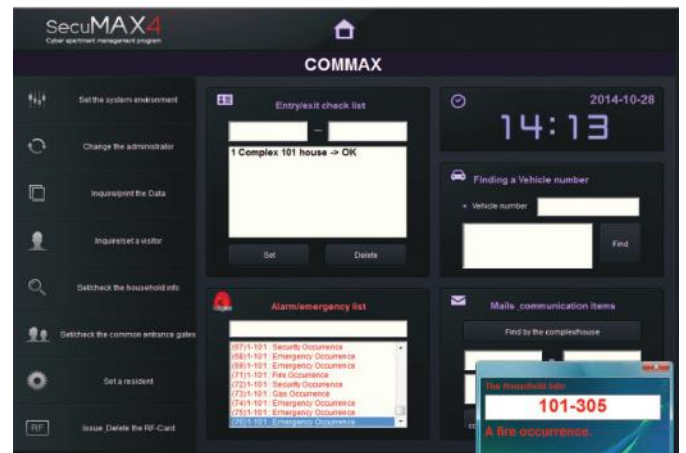

When alarm goes off in an emergency, the administrator can check the residence where the emergency occurred through the use of voice. Figure out when the alarm went off and stopped. Print alarm information. Make an emergency contact when the alarm was confirmed (SMS - Option).

## Common Entrance Control

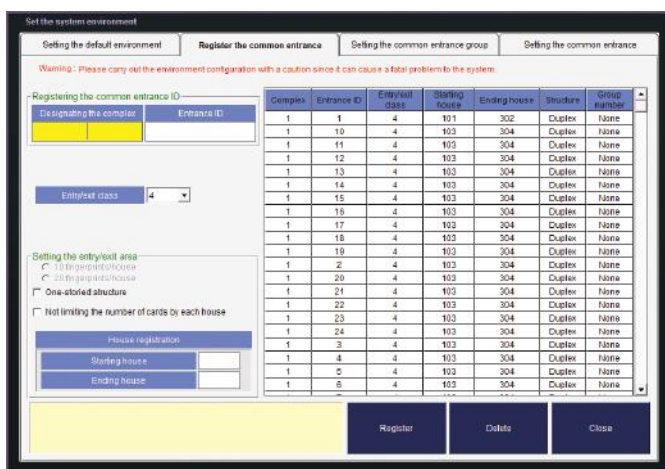

If common entrance needs to stay open for a long time due to a move or for other reasons, the entrance can be shut or opened through the use of PC. The state of the common entrance can be checked.

## Parking Management Control

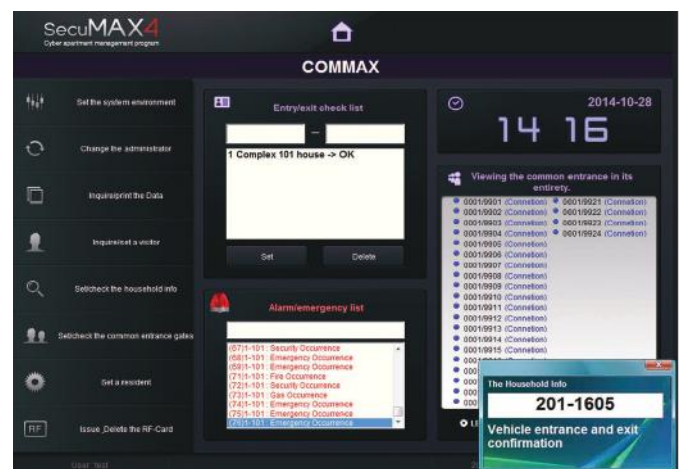

Possible to operate by connecting to parking Systems. It checks the state of each residence device and communications.



### 1. System requirements

- Processor: Pentium-4 or higher
- Operating system: Windows 2000/XP (Windows 2000 recommended)
- Memory: 512MB or more (the more memory, the higher performance)
- Hard disk: SCSI - 80GB or more
- Security device: MDC-201PC
- Communication: RS-232C MultiPort (8 Port)
- Monitor: VGA resolution or higher (1024 X 786) (17-inch monitor recommended)
- CD-ROM or DVD-ROM drive
- Microsoft mouse or compatible pointing device
- PC speaker

Caution: If a new SecuMax is installed, all previous data might be lost, so make sure to back up important files.

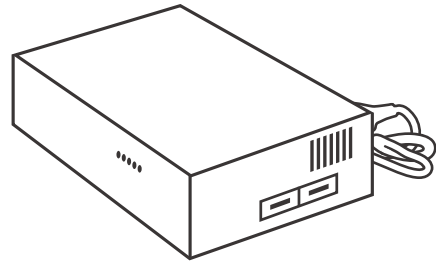

### 2. System Device Install (Security device-MDC201PC)

- Product overview
  - It reads RF-Card information, register it with SecuMax3 and implement inquiry.
  - It works as a security key of SecuMax3.
  - It can register card information with DRC at a high speed.
  - It can supply power at will at AC 100V to 220 V
  - It checks activity and communication state of devices through the use of an LED.
- Definition of product functions
  - It can check the current activity state of devices through a blinking LED.

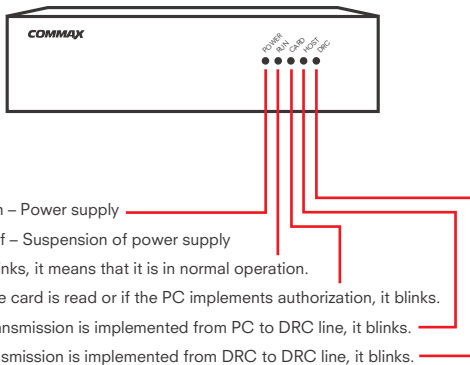

- It can communicate to a PC being connected to multiport.

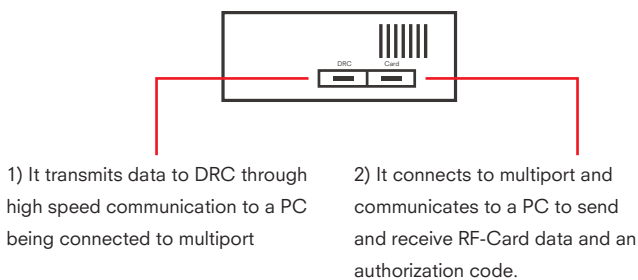

### 3. System Device Connection

- The multiport connects to 25 pins, and each device connects to 9 pins.
- The multiport consists of Com 3 through Com10 in the order of connection to the computer.
- The device connected to the multiport is connected to the console and MDC.
- Com 3 of the multiport is connected to the MDC "card" and used as an RF-Card input and security key.
- Com 4 of the multiport is connected to the DRC of the MDC and communicates to a DRC device at a high speed to download the RF-Card information and the residence card information.
- Com 5 of the multiport is connected to the guard station to implement a long-distance communication and send and receive various data.
- The length of lines should be 15 meters or shorter.
- Other Com ports are used to communicate to parking, home delivery and security companies.

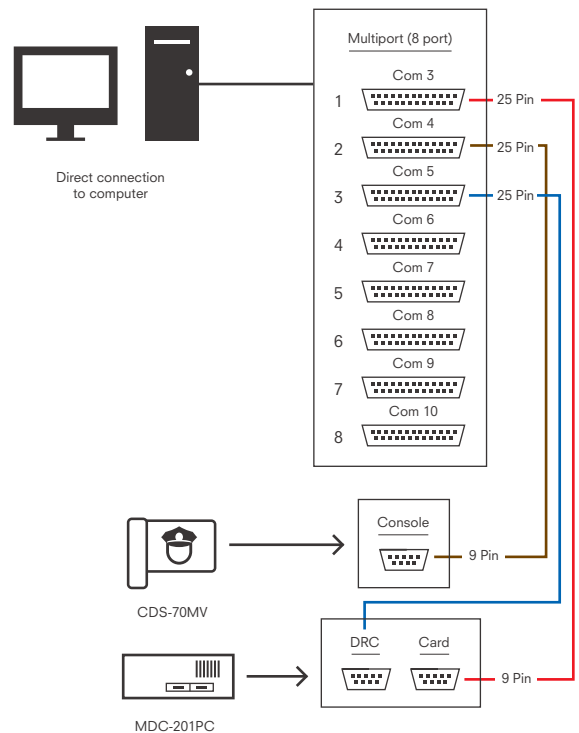



**COMMAX Co., Ltd.**

494, Dunchon-daero, Jungwon-gu,  
Sungnam-si, Gyunggi-do, 462-806, Korea

Phone +82-31-7393-540~550

Fax +82-31-731-2133

Web [www.commax.com](http://www.commax.com)



GOD DESIGN



reddot award 2014  
winner

